



# Koxtons®

**PUSH YOUR LIMITS**



PRODUCT  
**CATALOG**

 [www.koxtons.com](http://www.koxtons.com)

 [facebook.com/Koxton](https://facebook.com/Koxton)

 [Koxtonofficial](https://Instagram.com/Koxtonofficial)



# OUR CERTIFICATIONS

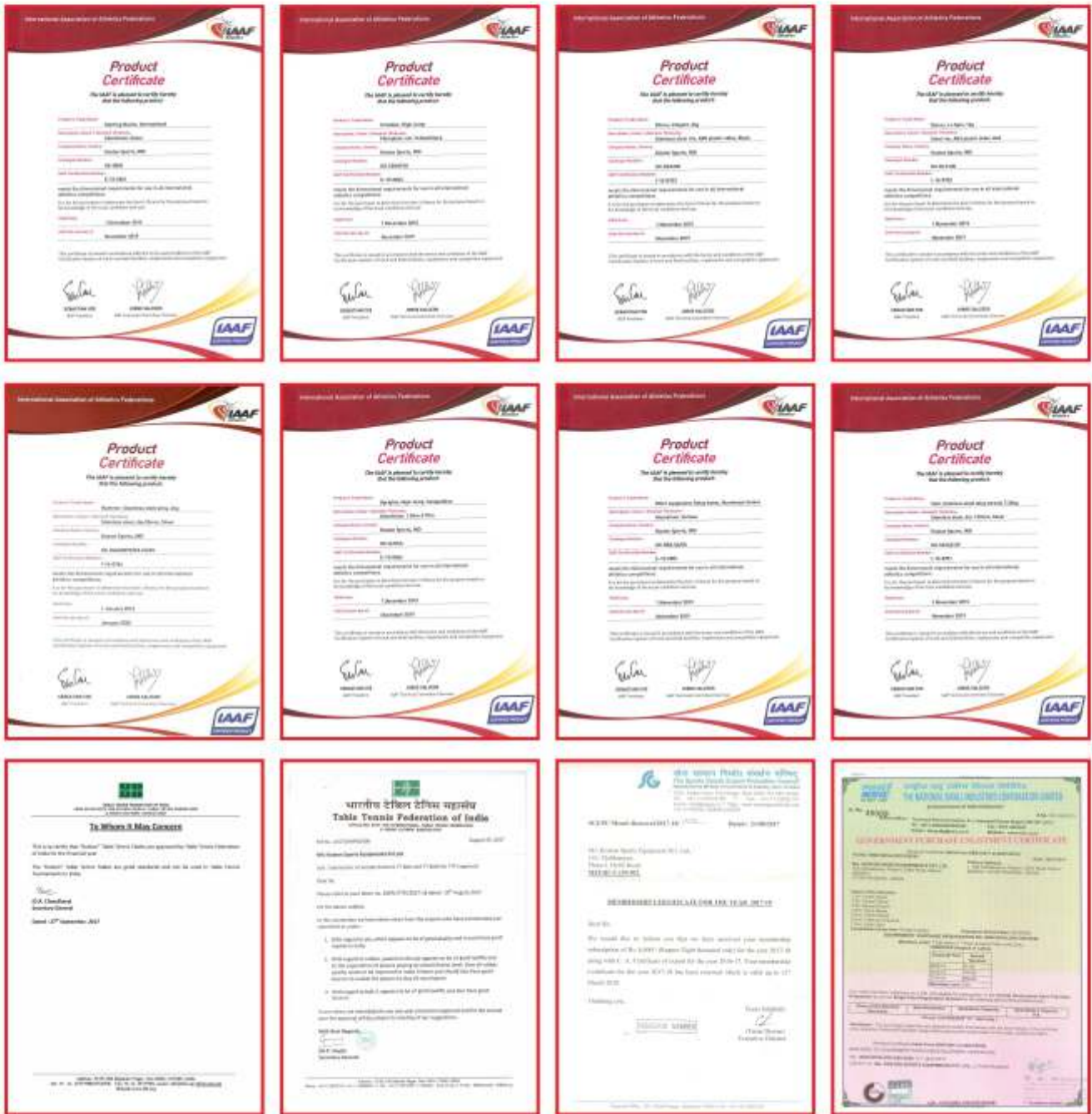

### Key Facts About Us

At Koxton Sports you are assured of quality sports products and services with the Highest International Standards. It's our pleasure to let you know some key facts about our company.

#### Infrastructure & Strength

- Geographic Markets: Worldwide (Including - USA, UK, Australia, France, Germany, Canada, Spain, Brazil, Poland and Qatar).
- Factory Size: 20000 Sq. Feets covered area with enhanced infrastructure.
- Quality Control: In-House.
- No. of R&D Staff: 5 Persons.
- Manufacturing 600+ Products.
- An ISO 9001:2008 Certified Company.
- TTFI Approved Table Tennis Tables.
- Registered Member of SGEPC (The Sports Goods Export Promotion Council) sponsored by Ministry of Commerce & Industry, Government of India).

#### Our Exclusive Services

- Product Development and Design.
- Mould Designing and Manufacturing.
- Existing Product Customization.
- Printing and Labeling.
- Product Branding and Packaging.
- Bar-Coding.

### Why Koxton Sports?

**Management:** Highly qualified and experienced team of professionals having vast experience in the field of production, marketing and managing a strong customer base for the last 4 decades. The entire team is well versed with latest technologies and tools to guide an experienced team of engineers, supervisors and workers to achieve high quality of each product produced in house with a focus on continuous improvement and development. Our dedicated team is continuously striving to develop new products based on the valuable feedback from our buyers and users.

**Innovation:** At Koxton Sports we are always looking for new ways to develop and design products by implementing latest and new technologies. We listen to our customers carefully and continually improve our systems in response to provide quality products and services. You can count us for innovative and cost-effective sports products and services.

**Quality & Reliability:** All our products confirm to the specifications of the FEDERATION of respective games. We have stringent quality checks at all levels and are working towards quality accreditation. All our vendors also follow stringent quality procedures and guidelines set by us so as to give a quality product.

**Customer Satisfaction:** We believe in "Total Customer Satisfaction". If you are satisfied, so are we. Quality, Environmental Health and Safety are our key focus areas and hence our products are made with these in our minds. Koxton Sports is dedicated to all Sports loving people and athletes who believe in "True Spirit of Sports".

**Dedication to Work:** At Koxton Sports team of dedicated and knowledgeable employees are committed to ensure that your experience is always good and positive. We are coming up with initial range of sports equipment into domestic market strategically through distribution facilities across the Country, plus facilities in Australia and New Zealand. Our dealer network is for the convenience of our end customers to obtain quality sports equipment at economical price at their place without any delay.

**Ethical Sourcing:** Koxton Sports seeks to do business with suppliers that do not engage illegal activities, child labour or forced labour of any nature.

### Our Core Values

Our core values are intended to guide and inspire us in all we say and do. Making sure that our values become part of our day-to-day work life is our mandate, and they help to ensure that our personal and professional behavior can be a model for all to follow. At Koxton Sports we believe that -

- Treating Everyone with Respect.
- Commitment to Leadership.
- Honesty and Integrity in All We Say and Do.
- Providing Superior Quality Products and Services.
- Innovation and Excellence.
- Social Responsibility.
- Safety & Assurance.
- Ensuring the Best Customer Satisfaction.
- Effective Team Work and Relationship.

### Our Strengths

- Business Expertise and 40 Years of Manufacturing Experience.
- Highly Skilled and Dedicated Manpower.
- The Ability to Provide Customized Solutions.
- Innovative Design and Development.
- Huge Production Capacity.
- Expertise with a Variety of Different Products.



## CONTENTS

<u>CATEGORY</u>	<u>PAGE NO.</u>
<b>HOME GYM</b>	Home Gym KX-HG8000 ..... 01
	Home Gym KX-HG8001 ..... 02
	Home Gym KX-HG5000 ..... 03
<b>STANDING PULL UP PARALLEL PUSH UP BAR</b>	Standing Pull UP Parallel Push UP Bar ..... 04
<b>MULTI PURPOSE BENCH</b>	6-IN-1 MULTI PURPOSE BENCH ..... 05
	8-IN-1 MULTI PURPOSE BENCH ..... 05
<b>AGILITY &amp; SPEED TRAINING</b>	Saucer Cone & Cone Marker ..... 06-08
	Agility Hurdle ..... 09-10
	Agility Ladder & Flat Ring ..... 11-12
	Corner Flag & Referee Flag ..... 13
	Training Pole & Dome Base ..... 14
	Flying Disc Big & Sponge Ring ..... 15
	Agility Kit ..... 16
	Pop up Goal, Speed Chute & Resistance Weight ..... 17
	Rebounder & Tchoukball Frame ..... 18
	Skipping Rope ..... 19-21
	Whistle ..... 22
	Relay Baton ..... 23
Agility Hoops ..... 24	
<b>BADMINTON</b>	Badminton Racket & Accessories ..... 25-28
	Shuttlecock & Accessories ..... 29
	Badminton Net ..... 30-31
<b>SPORTS BALL</b>	Football ..... 32-33
	Football Accessories ..... 34
	Ball Carrying Cart & Cage ..... 35
	Penalty Dummy & Stand ..... 36
	Stocking ..... 37
	Volleyball & Shooting Ball ..... 38-39
	Basketball & Accessories ..... 40
Volleyball Net & Accessories ..... 41-42	
<b>BOARD GAMES</b>	Carrom Board & Carrom Stand ..... 43-44
	Carrom Men & Striker ..... 45
	Carrom Powder ..... 46
	Chess Board ..... 47
	Chessmen ..... 48
	Dart Board, Ludo & Tambola ..... 49
<b>BOXING</b>	Boxing Ring ..... 50
	Boxing Punching Bag & Wrestling Dummy ..... 51
<b>CRICKET EQUIPMENTS</b>	Cricket Bat ..... 52-54
	Cricket Ball ..... 55
	Cricket Stumps ..... 56
	Cricket Leg Guard ..... 57-58
	Thigh Pad ..... 59
	Keeping Gloves ..... 60
	Cricket Batting Gloves ..... 61
	Cricket Helmet & Inner Gloves ..... 62
	Cricket Bat Grip & Cricket Accessories ..... 63-64
	Cricket Kit Bag & Gym Bag ..... 65-67
Cricket Cage, Net & Pitch Roller ..... 68	

## CONTENTS

<u>CATEGORY</u>	<u>PAGE NO.</u>
<b>FITNESS &amp; GYM EQUIPMENTS</b>	• Weight Lifting Bars ..... 69
	• Weight Plates ..... 70
	• Dumbbells ..... 71
	• Dumbbells Rack & Stand ..... 72
	• Plate Rack & Adjustable Squat Rack ..... 73
	• Gym & Fitness Accessories ..... 74-80
<b>SPORTS ACCESSORIES</b>	• Supporters ..... 81
	• Knee Cap ..... 82
	• Anklet, Elbow & Sports Band ..... 83-84
	• Sports Gloves ..... 85
<b>GOAL POSTS   POLES</b>	• Basketball Equipments ..... 86-91
	• Basketball Ring ..... 92
	• Football & Mini Goal Post ..... 93-94
	• Hockey & Hand Ball Goal Post ..... 95
	• Volleyball Goal Post ..... 96
	• Badminton Post & Kho Kho Post Field Accessories ..... 97-98
	• Refree Chair ..... 99
	• Lawn Tennis Post & Net Ball Post ..... 100-101
• Hand Ball, Hockey Goal Net & Tennis ..... 102	
<b>ROLLER SKATES</b>	• Roller Skates & Accessories ..... 103-105
<b>TABLE &amp; ACCESSORIES</b>	• Table Tennis Table ..... 106-109
	• TT Table Accessories ..... 110
	• TT Racket ..... 111
	• TT Balls ..... 112
	• Pool Table & Billiard Table ..... 113
<b>TRACK &amp; FIELD ATHLETICS</b>	• Discus ..... 114
	• Hammer & Accessories ..... 115-116
	• Shot Put ..... 117
	• Starting Block ..... 118
	• Crossbar & Javelin ..... 119
	• Hurdle ..... 120-121
	• Pole Vault Stand ..... 122
	• High Jump Stand ..... 123
	• High Jump Pit ..... 124
	• Pole Vault Pit & Toe Board ..... 125
	• Plyometric Box & Victory Stand ..... 126
• Judges Stand & Starter Clapper ..... 127	
• Carrying Cart ..... 128-129	
<b>GYMNASTIC EQUIPMENTS</b>	• Artistic Gymnastic ..... 130-134
	• Mats Sports & Gym ..... 135-137
	• Wrestling Mat & Cover ..... 138
<b>WEIGHT LIFTING &amp; FITNESS</b>	• 3-IN-1 Multi Purpose Bench ..... 139
	• Gym Machine ..... 140-141
	• Strength Equipment ..... 142-147
	• Treadmill & Airbike ..... 148
	• Multi Station Gym ..... 149-151
	• Multi Functional Trainer Smith Machine (Combo) ..... 152
	• Olympic Set ..... 153
• Outdoor Gym ..... 154-161	
<b>OTHER PRODUCTS</b>	• Other Products ..... 162



# HOME GYM

## KX-HG8000



Koxtons Home Gym Machine is very user friendly by its design and simple structure with premium quality spare parts. Structure is made of steel pipe frame with top quality powder coating for stability and durability of the home gym. All parts and accessories used are of fine quality and each being checked thoroughly before fixing for quality checks.

60mm OD Round Pipe Structure

**PVC WEIGHT STACK 50KG**

Maximum User Weight 120kg

**KX-HG8000**

### Accessories

- Lat Bar
- Silver Bar
- Triceps Rope

### Exercise

- Standing Tricep Extension
- High Cable Crunch
- Lat Pull Down
- Biceps Curl
- Chest Fly
- Cable Row
- Leg Extension
- Shoulder Raise
- Ches Press
- Upright Row

### OTHER ACCESSORIES AVAILABLE



WIRE SET (3 PCS)



WIRE



PULLY



FOAM ROLLER

# HOME GYM

## KX-HG8001



Koxtons Home Gym Machine is very user friendly by its design and simple structure with premium quality spare parts. Structure is made of steel pipe frame with top quality powder coating for stability and durability of the home gym. All parts and accessories used are of fine quality and each being checked thoroughly before fixing for quality checks.

60mm OD Round Pipe Structure  
**STEEL WEIGHT STACK 60KG**  
 Maximum User Weight 120kg  
**KX-HG8001**

### Accessories

- Lat Bar
- Silver Bar
- Triceps Rope

### Exercise

- Standing Tricep Extension
- High Cable Crunch
- Lat Pull Down
- Biceps Curl
- Chest Fly
- Cable Row
- Leg Extension
- Shoulder Raise
- Ches Press
- Upright Row

### OTHER ACCESSORIES AVAILABLE



WIRE SET (3 PCS)



WIRE



PULLY



FOAM ROLLER



MS WEIGHT STACK 60kg





# HOME GYM

## KX-HG5000



Koxtons Home Gym Machine is very user friendly by its design and simple structure with premium quality spare parts. Structure is made of steel pipe frame with top quality powder coating for stability and durability of the home gym. All parts and accessories used are of fine quality and each being checked throughly before fixing for quality checks.

**60mm OD Square Pipe Structure**  
PVC Weight Stack 50kg  
Maximum User Weight 120kg

**KX-HG5000**

### Accessories

- Lat Bar
- Silver Bar

### Exercise

- Standing Tricep Extension
- High Cable Crunch
- Lat Pull Down
- Biceps Curl
- Chest Fly
- Cable Row
- Leg Extension
- Shoulder Raise
- Ches Press
- Upright Row



### OTHER ACCESSORIES AVAILABLE



WIRE SET (3 PCS)



WIRE



PULLY



FOAM ROLLER



# Standing PULL UP PARALLEL PUSH UP BAR





## 6-IN-1 MULTI PURPOSE WEIGHT BENCH

It can be used for incline or decline and flat bench press, push ups, dumbbell fly, dumbbell press, leg curl, leg extension, parallel bar dips

KX-MPWH6-1



FLAT



DECLINE



3 IN 1 POSITION  
INCLINE / DECLINE / FLAT



3 IN 1 POSITION  
INCLINE / DECLINE / FLAT



FLAT

It can be used for incline or decline and flat bench press, push ups, dumbbell fly, dumbbell press, butterfly, leg curl, leg extension, parallel bar dips

KX-MPWH8-1



**SAUCER CONE - CONCAVE CUT**

- Concave Cut Saucer Cone soft plastic 5.5cm height & 18cm base diameter.
- Come with Plastic Stand to hold set of cones. Available in assorted colours.

**KX-SCC250** Set of 50 pcs  
**KX-SCC240** Set of 40 pcs  
**KX-SCC21** Single Piece

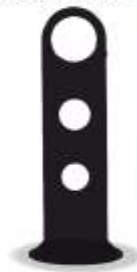



**SOCCER CONE - REGULAR**

- Saucer cone 5.5cm Height, & 18cm base diameter made of plastic.
- Come with plastic Stand Available in assorted colours.

**KX-SC250** Set of 50 pcs  
**KX-SC240** Set of 40 pcs  
**KX-SC21** Single Piece

**DOMe MARKER CONE**

- The Cones can be used for marking out pitches or setting up football training exercises.
- Cones are made from soft plastic with diameter 19 cm cone & height 7.5 cm.
- Available in assorted colours.

**KX-DMC40** Set of 40 pcs



**CONE MARKER - MEGA**

- These Cones can be used for marking out pitches or setting up football training exercises.
- 6" dome shape cones are made from plastic.
- Available in assorted colours.

**KX-CMM6**

# CONE MARKERS

# AGILITY & SPEED TRAINING

## FIELD CONE MARKER

- These Cones can be used for marking out pitches or setting up football training exercises.
- Cones are made from soft plastic.
- Available in assorted colours & size.

**CONE MARKER - 4"**  
KX-FCM0401



**CONE MARKER - 6"**  
KX-FCM0601



**CONE MARKER - 9"**  
KX-FCM0901



**CONE MARKER - 12"**  
KX-FCM1201



**CONE MARKER - 15"**  
KX-FCM1501



**CONE MARKER - 18"**  
KX-FCM1801



**CONE MARKER - WITH HOLE - 15"**

- These Cones can be used for marking training exercises.
- 15" hat shape cones with hole.
- Made from Plastic Available in assorted colours.

**KX-CMH151201**

**CONE MARKER - WITH HOLE 9"**

- These Cone Markers can be used for marking out pitches or setting up football training exercises.
- 9" hat shape cones with holes.
- Made from plastic.
- Available in assorted colours.

**KX-CMH91201**

**CONE MARKER - TOP HOLE - 9"**

- These Cone Markers can be used for marking & training exercises.
- 9" hat shape cones with top hole.
- Made from soft Plastic.
- Available in assorted colours.

**KX-CMTH901**

**FIELD MARKER FLAGS**

- Long lasting flag markers made of plastic.
- Available in assorted colours.

**KX-FMF01**

**REFEREE WALLET**

- Referee wallet made of rexine.
- Come with 2 cards Red & Yellow.

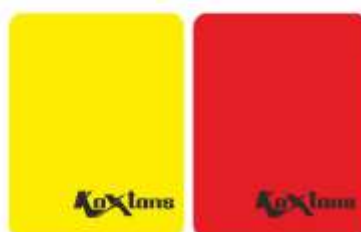
**KX-RFW**

**REFEREE - CARD**

- Referee wallet cards made of PVC.
- Available in different colours.

**KX-RFWCRS6** Red Set of 2 Pcs.

**KX-RFWCYS6** Yellow Set of 2 Pcs.

### AGILITY HURDLE

- Hurdle made of durable heavy duty PVC tube very light weight.
- A perfect training hurdle, agility and foot speed, running drills and plyometric jumps.
- Available in different sizes.

<b>KX-ATH061</b>	6" Height
<b>KX-ATH091</b>	9" Height
<b>KX-ATH121</b>	12" Height
<b>KX-ATH151</b>	15" Height
<b>KX-ATH181</b>	18" Height



### AGILITY HURDLE - COLLAPSIBLE

- Hurdle made of PVC tube with fully collapsible hurdle with internal locking mechanism.
- Height can be adjusted at 3" to 15".
- Height can be adjusted at 12" to 20".

**KX-AHC1**

### AGILITY HURDLE - MULTI PURPOSE

- Hurdle made of durable heavy duty PVC tube, very light weight.
- Dual movement of legs to use hurdle in two heights 6" & 12".

**KX-AHM612**



### BOUNCE BACK HURDLE

- Hurdle made of PVC tube, very light in weight.
- One piece construction, balanced to return to the upright position when knocked over.
- Available in different heights.

<b>KX-BBH06</b>	6" Height
<b>KX-BBH09</b>	9" Height
<b>KX-BBH12</b>	12" Height
<b>KX-BBH15</b>	15" Height
<b>KX-BBH18</b>	18" Height

**CONCAVE CUT SOCCER CONE HURDLE SET - 2 INCH**

- Cone hurdle made of plastic.
- Cones and poles can be organized in a variety of ways to create obstacles.
- Hurdle set consist of 20 pcs Cone + 10 pcs Pole 80 cm

**KX-SCH2010**



**MEGA CONE HURDLE**

- Cones and poles can be placed as per requirement.
- Hurdle set consist of 4 pcs Cone + 4 pcs Pole.

**KX-MCH644**

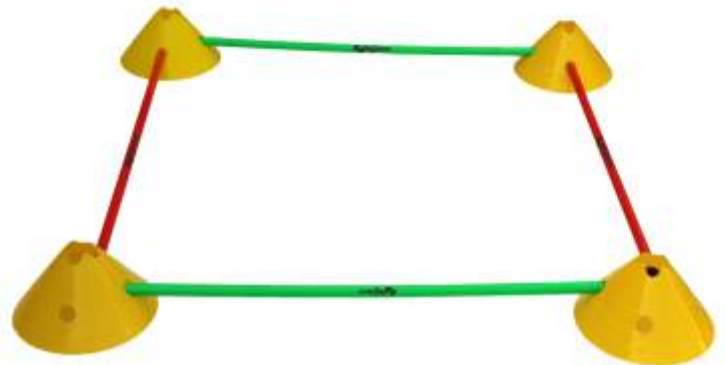

**CONE TRAINING HURDLE SET**

- Perfect for stepping and quick knee lifting comes in 2 option 12" & 15" set.



**KX-CTHS15**

(2 Pcs cone 15", 2 Clip, 2x80cm Poles & 1x100cm Poles)



**KX-CTHS12**

(2 Pcs cone 12", 2 Clip, 2x80cm Poles & 1x100cm Poles)



## AGILITY LADDERS

## AGILITY & SPEED TRAINING

### AGILITY LADDER PREMIUM (4 Mtr.)

- Agility Ladder 4 meter length, with 10 rungs, heavy-duty plastic rungs comes in a carry bag.
- KX-ALP40**



### AGILITY LADDER PREMIUM (8 Mtr.)

- Agility Ladder 8 meter length, with 20 rungs, heavy-duty plastic rungs comes in a carry bag.
- KX-ALP80**



### AGILITY LADDER - ADJUSTABLE

- Heavy duty plastic construction adjustable rungs to offer flexibility for adjusting the distance between the rungs.
- Available in different sizes.
- Comes with polyester bag.

**KX-ALAD40** 4mtr 10 rungs  
**KX-ALAD80** 8mtr 20 rungs  
**KX-ALAD90** 9mtr 23 rungs



### AGILITY LADDER - FIXED

- Agility ladders are perfect for a variety of drills and warm-up activities. Great for indoor or outdoor use.
- Heavy duty plastic construction with fixed rungs.
- Available in different sizes.
- Comes with polyester bag.

**KX-ALFD40** 4mtr 10 rungs  
**KX-ALFD80** 8mtr 20 rungs

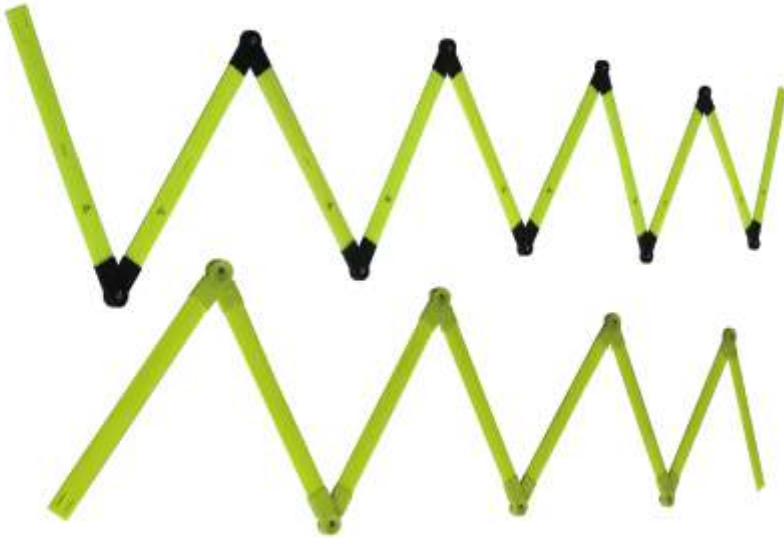
**ANTI SLIP CRISSCROSS LADDER**

- Koxtons crisscross ladder made of anti slippery material for a perfect drill and training.
- This set comes in single colour.

**KX-ASCL40** 4mtr Long with bag (single color)**KX-ASCL80** 8mtr Long with bag (single color)

Minimum order quantity : 15 Pcs.

**AGILITY HOOP LADDER**

- Made of 12 heavy duty hoops connected using velcro loops, agility ladder is easy to fold allowing you to twist it into different shapes and configurations.
- Available in 12 & 24 hoops (comes with mesh carry bag).

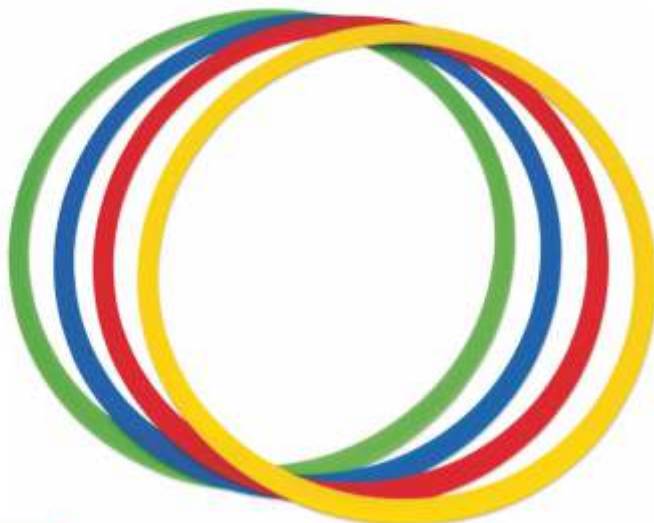
**KX-AHL12** with 12 hoops**AGILITY FLAT RINGS**

- These flat rings are best for performing drill activities to improve body balance.
- It comes in different colours.
- Outer Dia is 19 Inch.

**KX-AFR19**

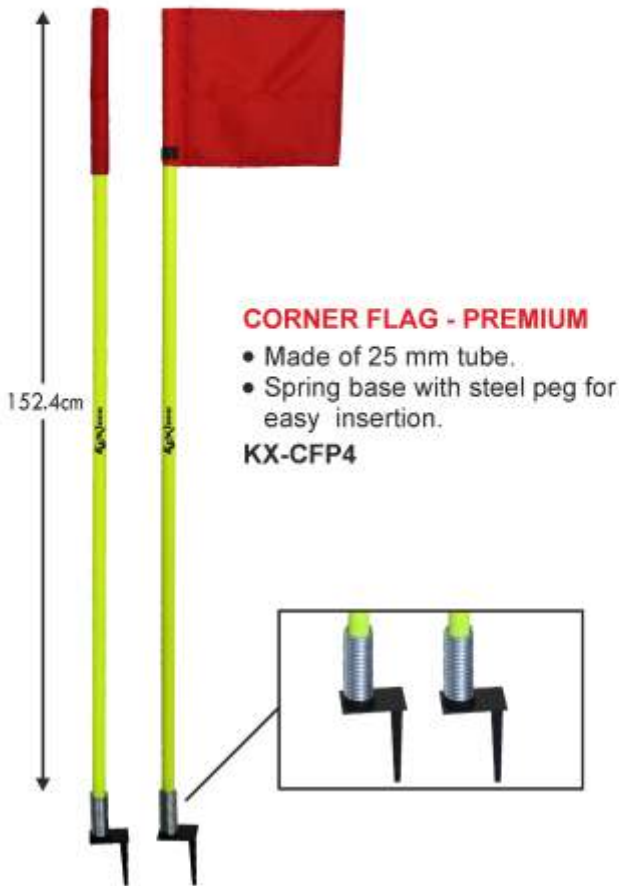

**CORNER FLAG - PREMIUM**

- Made of 25 mm tube.
- Spring base with steel peg for easy insertion.

**KX-CFP4**

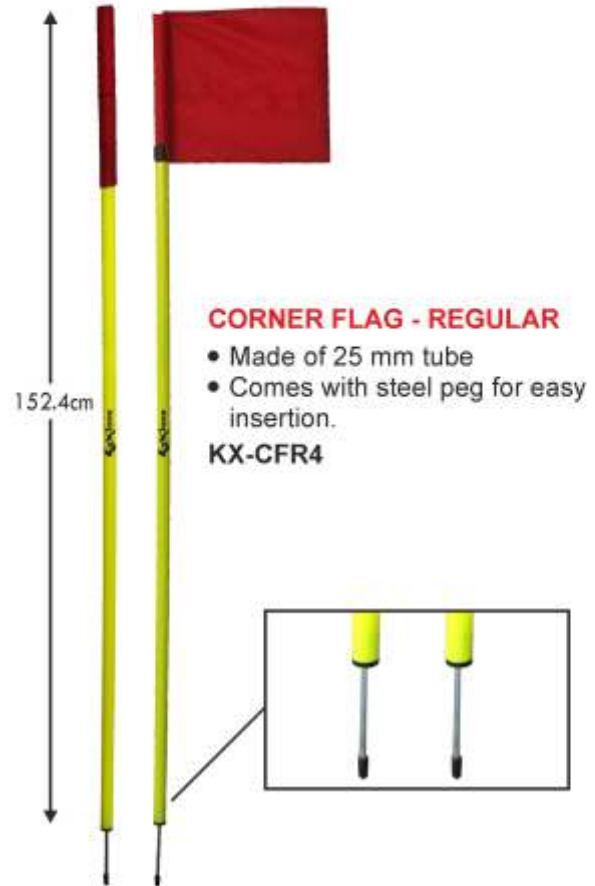

**CORNER FLAG - REGULAR**

- Made of 25 mm tube
- Comes with steel peg for easy insertion.

**KX-CFR4**

**REFEREE FLAG - DIAMOND**

- Lineman's flag made of polyester fabric with Red/Yellow diamond pattern, stick made of plastic with non-slip grip.

**KX-RFD**



**REFEREE FLAG - RED & YELLOW**

- Lineman's flag made of polyester fabric. Stick made of plastic with non-slip grip so you can make the right call in all conditions.
- Come with plastic clip to fixed the flag with stick.

**KX-RFY**

### SLALOM POLE - REGULAR

- Light weight slalom pole made of durable plastic without spring spike ends covered by thick rubber for safety.
- Available in different colours & lengths.

**KX-SPR1501**

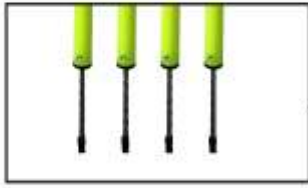

152.4cm

### SLALOM POLE - SPRING SPIKE

- Light weight slalom pole made of durable plastic.
- Agility pole with spring spike in order to return to its actual position if knock by the player height above the ground 152.4cm.

**KX-SPS1501**

**HEAVY DUTY SPRING**



152.4cm

### SPARE POLES - PVC

- Poles are made of 25mm strong plastic, each pole have caps at both end.
- Available in different colors and sizes.

**KX-SPP2508 80 CM**

**KX-SPP2510 100 CM**

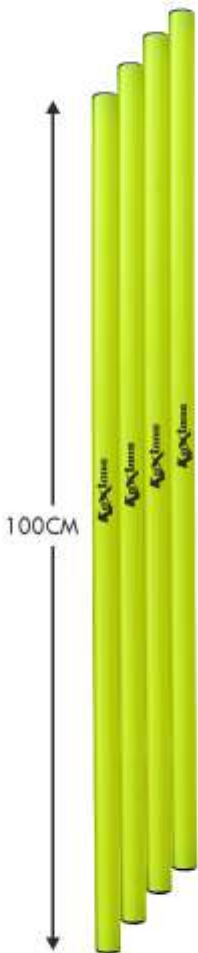

100CM

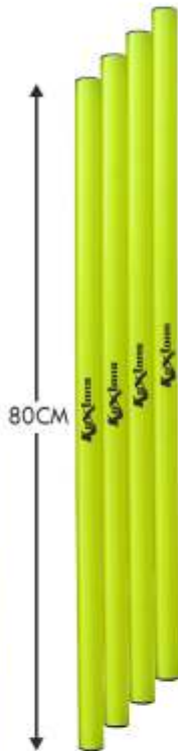

80CM

### DOME BASE- HEAVY

- Yellow base made of plastic.
- It can be used for 25 mm poles.
- This base can be filled with sand or water.

**KX-DBH**



### DOME BASE MULTIPURPOSE PREMIUM

- Yellow base made of plastic.
- It can be used for flat, 21 mm hoop & 25 mm poles.
- This base can be filled with sand or water.

**KX-DBMP**



### DOME BASE MULTIPURPOSE REGULAR

- Yellow base made of plastic.
- It can be used for flat, 18 mm hoop & 25 mm poles.
- This base can be filled with sand or water.

**KX-DBMR**



**FLYING DISC BIG**

- Flexible and soft for easy throwing and catching.
- Ideal for use outdoors in open spaces.
- Material : Made of plastic.
- Color : Assorted colors.
- Size : 26.5cm

**KX-FDL**



**FLYING DISC MEDIUM**

- Flexible and soft for easy throwing and catching.
- Ideal for use outdoors in open spaces.
- Material : Made of plastic.
- Color : Assorted colors.
- Size : 24cm

**KX-FDM**

**FLYING DISC SMALL**

- Flexible and soft for easy throwing and catching.
- Ideal for use outdoors in open spaces.
- Material : Made of plastic.
- Color : Assorted colors.
- Size : 21.5cm

**KX-FDS**



**SPONGE RING - REGULAR**

- Ring made of soft rubber which gives you soft feeling like sponge.
- It can be used for various kinds of catching & throwing games to develop hand and eye co-ordination.

**KX-SPR6 6" rubber ring**

**KX-SPR7 7" rubber ring**



**SPONGE RING - DOTTED**

- Ring made of soft dotted rubber which gives you better grip.
- It can be used for various kinds of catching & throwing games to develop hand and eye co-ordination.

**KX-SPRD**

**AGILITY TRAINING KIT- ACTIVITY**

An ideal way to improve your speed, agility, balance, co-ordination and stamina for any sport.

**Agility set include:**

- 6 Pcs x 6" Hurdles
- 6 Pcs x 9" Hurdles
- 40 Pcs x 2" Cone Markers
- 10 Pcs x 6" Cone Markers
- 10 Pcs x 9" Cone Markers
- 1 Pc x 4m Adjustable Ladders  
Comes in a bag.

**KX-ATKA**



**POP UP GOAL**

- Pop up goal comes in different sizes best for training of all field sports.
- High quality Mesh fabric is used.

<b>KX-PUGS2</b>	80 cm x 45 cm
<b>KX-PUGM2</b>	110 cm x 80 cm
<b>KX-PUGL2</b>	180 cm x 110 cm



**SPEED CHUTE**

- Speed Chute is made up of good quality Nylon fabric with panels for extra stability of the chute.

<b>KX-SCS40</b>	40"
<b>KX-SCM48</b>	48"
<b>KX-SCL56</b>	56"
<b>KX-SCX64</b>	64"



**RESISTANCE WEIGHT SLEDGE**

- Made of heavy duty tubular steel, turned around steel plate, powder coated for extra durability.
- Length : 21.5 Inches
- Width : 14.5 Inches
- Post height : 9 Inches

<b>KX-RWSLWB</b>	with waist belt
<b>KX-RWSLHB</b>	with harness belt

**RESISTANCE WEIGHT SLEDGE - PRO**

- Made from heavy duty and powder coated steel pipes & plates.
- Comes with a threaded column to mount weight plates at the center of the sledge.

**KX-RWSP**



**REBOUNDER - REGULAR**

- The Mini Rebounder is a great training device for developing players, especially goalies.
- It is portable, so players can work out on the soccer field and it folds flat for easy transportability.
- Rebounder made of metal tube, strong enough to use.
- Elastic around netting for extra rebound.
- Adjustable angle positions to control the angle of returning ball, the Mini Rebounder comes complete with frame, net, hardware.

**KX-RBMPR 1M x 1M****TCHOUKBALL FRAME**

- Made of 32 mm tubular steel frame, come with net and hardware.
- Dimension 100 cm x 100 cm.
- Comes with anti slip pads 3 mm braided PP net along with the bungee cord attachment for connection net with the frame.

**KX-TCHF 1M X 1 M**



## SKIPPING ROPE

## AGILITY & SPEED TRAINING



### JUMP ROPE CLUB

- Lightweight foam handle for increased comfort.
- Highly durable product as made from high quality materials.

KX-JRPH075



### JUMP ROPE FLORO

- Foam handle Nylon rope, non-adjustable high quality jump rope made from cable for long durability.
- Designed for athletes of all levels.

KX-JRPH300



### JUMP ROPE TRAINING

- Wooden handle skipping rope with spring for more protection.

KX-JRWH200



### JUMP ROPE BURNER

- PVC coated steel wire, heavy wooden handle.

KX-JRWH055



### JUMP ROPE CHALLENGER

KX-JRPH1000



### JUMP ROPE SPEEDO

KX-JRPH2000



**JUMP ROPE REBIND**  
KX-JRWH045



**JUMP ROPE ORCHID**  
KX-JRPH666



**JUMP ROPE ZORO**  
KX-JRPH555



**JUMP ROPE PRACTICE**  
KX-JRWH105



**JUMP ROPE MAGNUM**  
KX-JRPH777



**JUMP ROPE ARON**  
KX-JRPH222



**JUMP ROPE COTTON**

- Wooden handles without paint are comfortable for all hand sizes light weight cotton braided rope moves nicely

**KX-JRWH100**



**JUMP ROPE ACTIVE**

**KX-JRPH333**



**JUMP ROPE ECO**

**KX-JRPH030**



**JUMP ROPE SKIPPER 444**

**KX-JRPH444**



**WHISTLE PRO**  
KX-WBPB (With Laneyard)



**WHISTLE PRO**  
KX-WPJP (With Laneyard 24 Pcs)



**WHISTLE THUNDER**  
KX-WTJP (With Laneyard 24 Pcs)



**WHISTLE THUNDER**  
KX-WTBP (With Laneyard)



**WHISTLE ECO**  
KX-WEBP (12 Pcs Box Packing)



**WHISTLE ECO**  
KX-WEJP  
(100 Pc Jar Packing)



**RELAY BATON - ALUMINIUM**

- Relay Baton made of Aluminium smoothly turned from both ends with anodized.
- Available in different colours.

**KX-RBAS8** Set of 8 Pcs.



**RELAY BATON - ALUMINIUM**

- Relay Baton made of Aluminium smoothly turned from both ends with anodized.
- Available in different colours.

**KX-RBAS6** Set of 6 Pcs.



**RELAY BATON - PVC**

- Relay Baton made of plastic with smooth rounded ends.
- Available in different colours.

**KX-RBPS6** Set of 6 Pcs.

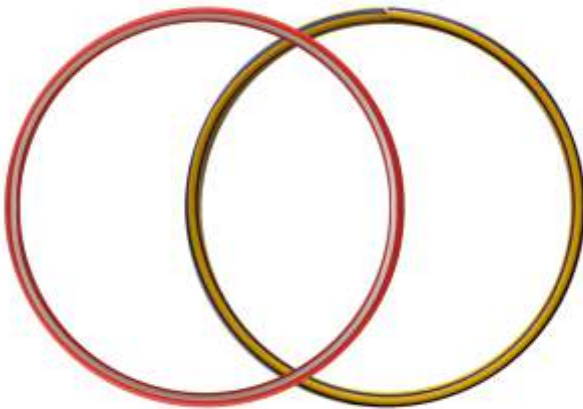

**HOOP DOUBLE COLOR**

<b>KX-GHDC18</b>	18 Inch
<b>KX-GHDC24</b>	24 Inch
<b>KX-GHDC30</b>	30 Inch

**HOOP - PREMIUM**

- Single Colour

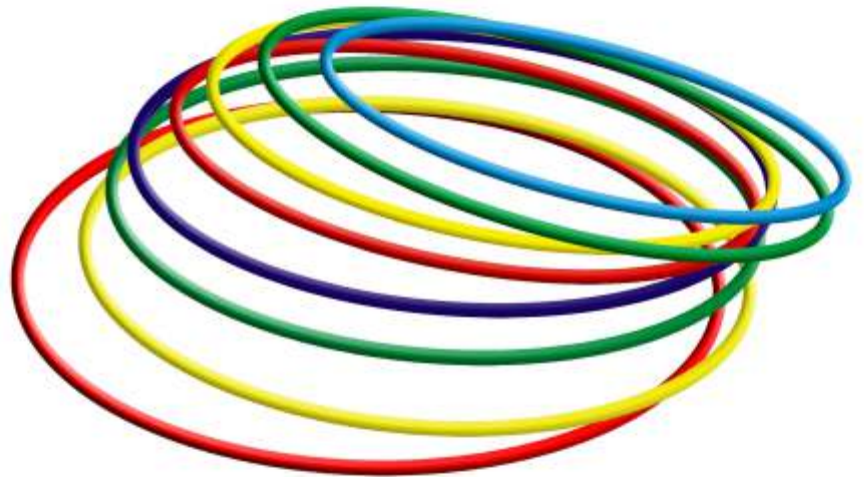
<b>KX-GHP18</b>	18 Inch
<b>KX-GHP24</b>	24 Inch
<b>KX-GHP30</b>	30 Inch
<b>KX-GHP36</b>	36 Inch

**HOOP - FOLDING**

- Hula hoop made of High Impact Plastic.
- A set of 8 arc's joined together of different colors make a ring.

**KX-GHF8** 30 Inch

U.H.M. GRAPHITE SHAFT



**INFINITY**

- Isometric Shape
  - U.H.M. Graphite Shaft
  - Wide body
  - Tension 22 to 24 LBS
  - PU Grip 4U
  - Heavy Duty Padded Cover
  - Weight 90 to 95gm
- KX-BRI**



**PRO ENERGY**

- Aero Diamond Shape
  - Carbon Graphite Shaft
  - Tension 22 to 24 LBS
  - PU Grip
  - Heavy Duty Padded Cover
  - 76 Grommet Holes
- KX-BRPE**



**FORCE 999**

- Isometric Shape
  - High Modular Shaft
  - Wide Body
  - Sweat Absorbent Grip
  - Heavy Duty Padded Cover
- KX-BRF999**



**ELEGANT**

- Aero Dynamic Shape
  - Flexible Shaft
  - Wide body
  - Double Color PU Grip
  - Special Material Full Cover
  - Heavy Duty Padded Cover
- KX-BRE**



**MASTER**

- Aero Dynamic Shape
  - Flexible Shaft
  - Wide body
  - PU Grip
  - Special Material Full Cover
  - Heavy Duty Padded Cover
- KX-BRM777**

POWER JOINT RACKET



VINYL PAINT  
MATT FINISH

**SWING POWER**

- Full Tetron Cover  
KX-BRSP



POWER FRAME  
GLOSSY

**SPEED 600**

- Full Tetron Cover  
KX-BRS600



SPRING DESIGN  
FRAME

**MEGA 555**

- Full Tetron Cover  
KX-BRM555



ALUMINIUM HEAD  
DUAL GROMMET

**MAX 500**

- Full Tetron Cover  
KX-BRM500



**BANG BANG**

- Full Tetron Cover  
KX-BRBB



**GIFT SET KX-30**

- With Cover  
KX-BRC30



**KX30**

- Poly Pack  
KX-BR30



**GIFT SET FORCE 10**

- With Cover  
KX-BRFC10



**FORCE 10**

- Poly Pack  
KX-BRF10





**GIFT SET DS20**  
 • With Cover  
 KX-BRDSC20



**DS20**  
 • Poly Pack  
 KX-BRDS20



**GIFT SET ULTRA**  
 • With Cover  
 KX-BRUC



**ULTRA 3/4" COVER**  
 • Poly Pack  
 KX-BRU



**GIFT SET KLUB**  
 • With Cover  
 KX-BRKC



**KLUB**  
 • Poly Pack  
 KX-BRK



**GIFT SET KX30JR**  
 • Junior Size For Kids  
 • With Cover  
 KX-BRJC30



**KX30JR**  
 • Junior Size for Kids  
 • Poly Pack  
 KX-BRJ30



**GIFT SET KLUB JR**  
 Junior Size for Kids  
 • With Cover  
**KX-BRKJC**



**KLUB JR**  
 • Junior Size for Kids  
 • Poly Pack  
**KX-BRKJ**



**BADMINTON STRING LEGEND**  
 • 0.75mm Thickness  
**KX-BSL**



**BADMINTON STRING XPRESS**  
**KX-BSX**



**BADMINTON GRIP PREMIUM**  
**KX-BGP** 60 Pcs Per Box



**BADMINTON GRIP REGULAR**  
**KX-BGR** 60 Pcs Per Box

# SHUTTLECOCK & ACCESSORIES

# BADMINTON

## SHUTTLECOCK NYLON



## SHUTTLECOCK PLASTIC



## SHUTTLECOCK FEATHER



**KOX-700**  
KX-SC700



**KOX-800**  
KX-SC800



**KOX-900**  
KX-SC900



**NYLON NET**

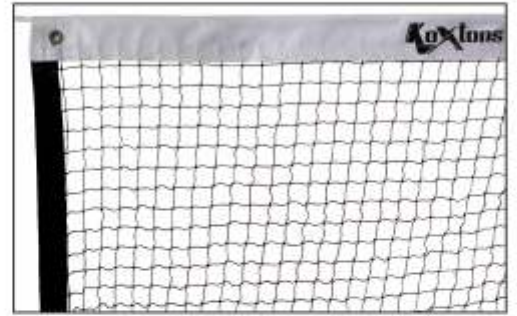

**TOURNAMENT PRO**

- Made of heavy duty Nylon Material
  - 4 Side Tetron Tape
- KX-BN116**



**TOURNAMENT**

- Made of Nylon Material
  - 3 Side Tetron Tape
- KX-BNT**



**KX-BN106**

- 4 Side Nylon Niwar
- KX-BN106**



**KX-BN115**

- 4 Side Nylon Niwar
  - White rope top & bottom
- KX-BN115**



**KX-BN105**

- 4 Side Nylon Niwar
  - Black rope top & bottom
- KX-BN105**



**KX-BN104**

- 1 Side Nylon Niwar
- KX-BN104**

**COTTON NET**

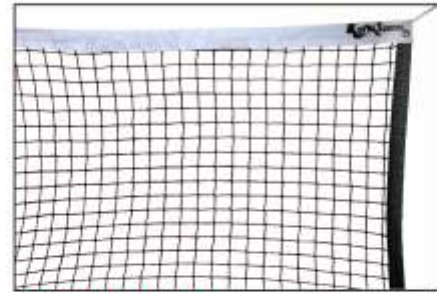

**TOURNAMENT**  
 • Made of Cotton Material  
 • 3 Side Tetron Tape  
**KX-BNCT**



**KOX-BN103**  
 • 3 Side Tetron Tape  
**KX-BN103**



**KOX-BN112**  
 • 4 Side Cotton Niwar  
**KX-BN112**



**KOX-BN102**  
 • 4 Side Cotton Niwar  
**KX-BN102**



**KOX-BN111**  
 • 1 Side Cotton Niwar  
**KX-BN111**

**KOX-BN101**  
 • 1 Side Cotton Niwar  
**KX-BN101**



**HAND SEWN FOOTBALL**

**STAR LEISURE**

- Shiny smooth PU leather ball.
- Suitable for hard ground.
- 32 panel hand stitched.
- Soft feel & perfect bounce.
- Panel shape octagon.
- Durable reinforced bladder.
- For professional play.
- Deflated ball with box packing.

**KX-FBSL      Size # 5**



**IMPACT**

- High quality PU leather ball.
- Suitable for hard ground.
- 32 panel hand stitched.
- Soft feel & perfect bounce.
- Panel shape octagon.
- Eight sides & eight angles.
- Durable reinforced bladder.
- For professional play.
- Deflated ball with box packing.

**KX-FBI      Size # 5**

**INFINITY**

- High quality PU leather ball.
- 32 panel hand stitched.
- Soft feel & perfect bounce.
- Panel shape octagon.
- Super control.
- Durable reinforced bladder.
- For professional play.
- Deflated ball with box packing.

**KX-FBIN      Size # 5**



**FREEDOM**

- High quality PU fusion ball.
- 32 panel hand stitched.
- Soft feel & perfect bounce.
- Panel shape octagon.
- Super control.
- Durable reinforced bladder.
- For professional play.
- Deflated ball with box packing.

**KX-FBFD      Size # 5**

**HAND SEWN FOOTBALL**

**ULTIMATE STAR**

- High quality synthetic rubber.
- Suitable for hard ground.
- 32 panel hand stitched.
- Hard feel & perfect bounce.
- Panel shape octagon.
- Durable reinforced bladder.
- For professional play.
- Deflated ball with box packing.

**KX-FBUS    Size # 5**



**MORE  
DURABLE**



**RACER**

- Synthetic rubber.
- Best grip.
- 32 panel hand stitched.
- Hard feel & perfect bounce.
- Panel shape excellent.
- Durable reinforced bladder.
- Training ball.
- Deflated ball with box packing.

**KX-FBRA    Size # 5**

**KX-FBN4    Size # 4**

**XTREME**

- Practice ball.
- Polyvinyl texture.
- 32 panel hand stitched.
- Perfect bounce.
- Excellent shape.
- Durable reinforced bladder.
- Available in assorted colors.
- Deflated ball with box packing.

**KX-FBXT    Size # 5**



**PRACTICE  
BALL**

**PRACTICE  
BALL**



**XPRESS**

- Practice ball.
- Polyvinyl texture.
- 32 panel hand stitched.
- Perfect bounce.
- Excellent shape.
- Durable reinforced bladder.
- Available in assorted colors.
- Deflated ball with box packing.

**KX-FBXS    Size # 5**

**KIDDY**

- Practice ball for kids.
- T panel hand stitched.
- Perfect bounce.
- Excellent shape.
- Available in assorted colors.

**KX-FBN3    Size # 3**

**KX-FBN1    Size # 1**





**SHIN GUARD MANCHESTER**

- Elastic with velcro.
  - Available in assorted color
  - Adjustable velcro strap
  - Stitched 6mm EVA Foam
  - Free Size
- KX-FSGB BIG**



**SHIN GUARD LIVERPOOL**

- Elastic with velcro.
  - Available in assorted color
  - Adjustable velcro strap
  - Stitched 6mm EVA Foam
  - Free Size
- KX-FSGS SMALL**



**HAND PUMP  
KX-FHPRS**



**SOCCER INFLATOR  
KX-SI**



**FOOTBALL NET NYLON HAND  
KNITTED**

- KX-FBN301 (1mm THICKNESS)
- KX-FBN302 (1.5mm THICKNESS)
- KX-FBN303 (2mm THICKNESS)
- KX-FBN304 (3mm THICKNESS)



**FOOTBALL NET NYLON MACHINE  
KNITTED**

- KX-FBN305 (1.5mm THICKNESS)
- KX-FBN306 (2mm THICKNESS)
- KX-FBN307 (3mm THICKNESS)

**BALL CARRYING BAG**

- Bag made of Tetron cloth & Mesh fabric combination with reinforced and drain holes.
- Adjustable shoulder strap.
- The bag has a carrying capacity of up to 8-12 balls.

**KX-BCBH4019 40"x19"**

**KX-BCBH3719 37"x19" (Heavy duty fabric)**







**FOOTBALL BALL CARRYING BAG MESH - SUPER**

- Bag made of 100% polyester mesh with two carrying handle.
- Bag has a carrying capacity of 8-10 balls.
- Size : 39" x 23"

**KX-BCB3923**



**BALL CARRYING BAG - MESH**

- Bag made of 100% polyester mesh with draw string & cord lock.
- Adjustable shoulder strap.
- The bag has a carrying capacity of 8-10 balls.
- Size : 37" x 24"

**KX-BCB3724**



**BALL CARRYING CAGE REGULAR**

- Ball Carrying cage made of heavy duty steel.
- Powder coated for durability with top opening and lockable lid.
- Can be easily assembled, capacity 25/30 balls.
- Size 42"x30"x30"

**KX-BCCR**



**BALL CARRYING CAGE CLUB**

- Ball Carrying cage made of heavy duty steel.
- Powder coated for durability can be easily assembled.
- Capacity 25/30 balls.
- Size 42"x30"x30"

**KX-BCCC**



**BALL CARRYING CART**

- Ball Carrying cage made of heavy duty steel.
- Size 42" x 40"

**KX-BCCAR**

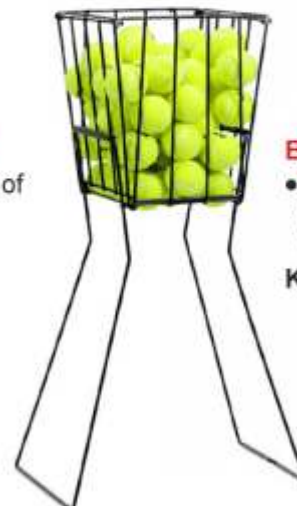

**BALL PICKUP BASKET**

- Tennis ball pick basket and stand made of steel wire, Holds 50 balls.

**KX-BPUB**



**FOOTBALL PENALTY DUMMY POLLY  
(WITHOUT BASE)**  
KX-FPDP160  
KX-FPDP180

**FOOTBALL PENALTY DUMMY  
POLLY BASE**  
KX-FPDPB      BASE Only

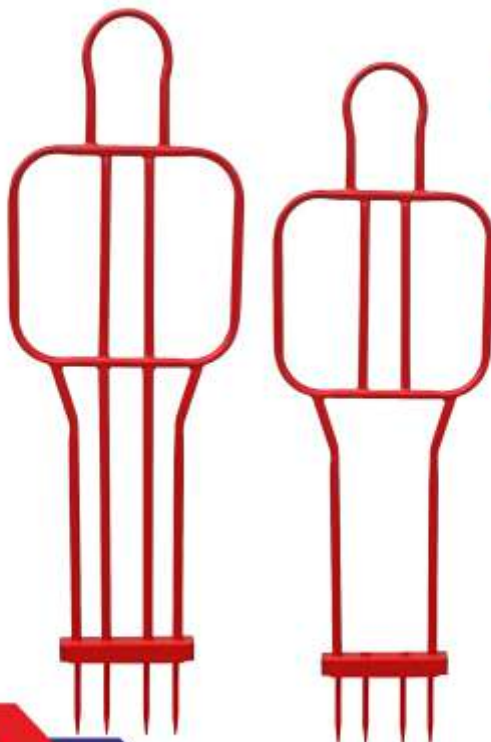

**FOOTBALL PENALTY DUMMY REGULAR  
(WITHOUT CART)**  
KX-FPDR160  
KX-FPDR180

**FOOTBALL PENALTY DUMMY REGULAR  
CART - SINGLE**  
KX-FPDRC      Cart Only

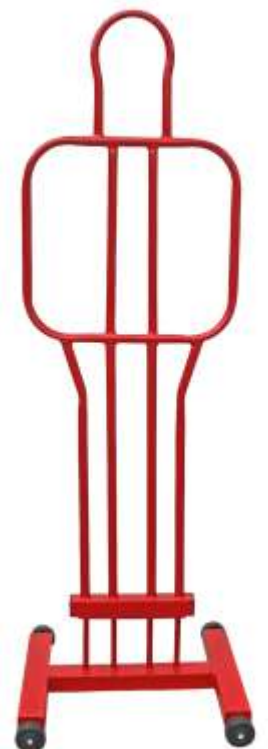
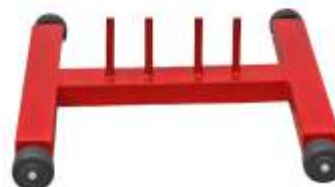



**ACTION**  
(FULL TERRY NYLON)  
**STABILITY**

- Elasticated band around the midfoot ensures much less sock slippage in play.

KX-SKA 1 PAIR



**VENTILATION**

- Ventilated area on the instep for improved ventilation.



**QUICK DRYING**

- Air dries quickly

**WAVE**  
(HALF TERRY POLY)  
**ANATOMIC DESIGN**

- You can comfortably set these socks to any length.

KX-SKW 1 PAIR



**STYLUS**  
(FULL TERRY POLY)  
**USER COMFORT**

- Heel and toe padding to keep your foot comfortable

KX-SKST 1 PAIR



**SPEED**  
(POLY)  
**LIGHT WEIGHT**

- 63g in size 8/9 1/2 quick drying

KX-SKSP 1 PAIR



**MAX JR**  
(POLY)  
**LIGHT WEIGHT**

- Quick Drying
- Full Stretch

KX-SKMJ 1 PAIR



**SIGNATURE**  
(NON TERRY)  
**STABILITY**

- Elasticated band around the midfoot ensures much less sock slippage in play.

KX-SKSM 1 PAIR



**SMASH SHOT**

- Dimpled surface PU
- 18 panels hand stitched
- For professional play
- Butyl bladder
- Better grip
- Long lasting
- Water resistant
- Inflated ball with box packing

**KX-VBSS**



**SUPER VOLLEY**

- Pasted composite leather ball.
- 18 Panels.
- For professional play.
- Butyl bladder.
- Nylon wound.
- Long lasting.
- Water resistant.
- Inflated ball with box packing.

**KX-VBSV**

**SHOOTER**

- Pasted composite leather ball.
- 8 Panels.
- For professional play.
- Butyl bladder.
- Nylon wound.
- Long lasting.
- Water resistant.
- Inflated ball with box packing.

**KX-VBSH**



**OPTIMA**

- Dimpled surface PU.
- 18 Panels hand stitched.
- For professional play.
- Butyl bladder.
- Better grip.
- Long lasting.
- Water resistant.
- Inflated ball with box packing.

**KX-VBHO**





**DIVINE**

- Dimpled surface PU.
- 18 Panels hand stitched.
- For professional play.
- Butyl bladder.
- Better grip.
- Long lasting.
- Water resistant.
- Inflated ball with box packing.

KX-VBDN

**SMASH**

- Dimpled surface PU
- 18 panels hand stitched
- For professional play
- Butyl bladder
- Better grip
- Long lasting
- Water resistant
- Inflated ball with box packing

KX-VBS



**SUPREME**

- Rubber moulded volleyball
- 18 panels hand stitched
- Better grip
- Long lasting
- Water resistant
- Official size & weight

KX-VBSU

**ULTIMA**

- Pvc dimpled volleyball
- 18 panels hand stitched
- Better grip
- Long lasting
- Water resistant
- Official size & weight

KX-VBUL



**U.H.M. GRAPHITE SHAFT**



**HI GRIP  
(PU LAMINATED)**

- Nylon wounded
- 4 panel, best grip
- Soft feel & perfect bounce
- For professional play
- Double color
- Long lasting durable
- Official size & weight

**KX-BBHG Size # 7**



**EDGE**

- Nylon wounded
- 14 panel, best grip
- Soft feel & perfect bounce
- Rubber upper
- Long lasting durable
- Official size & weight

**KX-BBED7 Size # 7**

**KX-BBED6 Size # 6**

**KX-BBED5 Size # 5**



**TWISTY**

- Rubber upper
- Nylon winding
- Soft feel

**KX-BBTW Size # 3**



**MICKY**

**KX-BBN3 Size # 3**



**BASKETBALL BOARD  
SET JR  
KX-BBSJ**



**BASKET BALL NET  
KX-BBN701 4MM**



**BASKET BALL NET  
KX-BBN702 6MM**



**BASKET BALL NET  
KX-BBN703 8MM**



**SHOOTING BALL - T PANEL  
(RACER)  
KX-SBRR**



**SHOOTING BALL - 32 PANEL  
(MAGNA)  
KX-SBMA**



**SHOOTING BALL NET  
(COTTON)  
KX-SBNC**

**VOLLEYBALL NETS NYLON**



**TOURNAMENT**

- 3 side tetron tape
- Official size & length
- Black color nylon
- Net 10 mesh
- PVC coated wire (box packing)

**KX-VNNT**

**HDPE KOX-213**

- 4 side tetron tape
- Black color nylon
- Net 10 mesh (box packing)

**KX-VN213**



**HDPE KOX-212**

- 3 side tetron tape
- Blue color nylon
- Net 10 mesh (box packing)

**KX-VN212**

**KOX-211**

- 4 side tetron tape
- White color nylon
- Net 10 mesh (with carry bag)

**KX-VN212**



**KOX-207**

- 4 side heavy duty nylon niwar
- Both side nylon tape, 10 mesh
- Black color (with carry bag)

**KX-VN207**



**KOX-205**

- 4 side heavy duty nylon niwar
- Blue color, 9 mesh (with carry bag)

**KX-VN205**

**SPORTS NET**

**VOLLEYBALL NET**



**KOX-204**  
 • 2 Side Nylon Niwar  
 KX-VN204



**KOX-203**  
 • 2 Side Nylon Niwar  
 KX-VN203

**COTTON NET**



**TOURNAMENT COTTON**  
 • 14cm canvas on top & 10cm bottom  
 • 10 mesh, official size (with box packing)  
 KX-VN214



**KOX-206**  
 • 4 side canvas tape.  
 • 10 mesh (with carry bag)  
 KX-VN206



**KOX-202**  
 • Both side cotton niwar  
 • 10 mesh size 10mtr x 1mtr.  
 KX-VN202



**KOX-201**  
 • Both side cotton niwar  
 • 9 mesh size 10mtr x 1mtr.  
 KX-VN201



**NET WIRE**  
 KX-VBNW4 Length 12M Thickness 4MM  
 KX-VBNW6 Length 12M Thickness 6MM



**NET ANTINA**  
 KX-VBNA





**PREMIUM FULL SIZE 3" BORDER**

- Carrom Board - Full Size comes with 3" border, made of good quality wooden border and 6MM plywood with perfect corners backed with good quality mesh net pocket. polish for better performance.

**KX-CBFS3** • Size - 35"x35"

**PREMIUM FULL SIZE 2" BORDER**

- Carrom Board - Full Size comes with 2" border, made of good quality wooden border and 6 MM plywood with perfect corners backed with good quality mesh net pocket. polish for better performance.

**KX-CBFS2** • Size - 33"x33"



**PREMIUM 1.5" BORDER**

- Carrom Board - 1.5" border, made of good quality wooden border and 4 MM plywood with perfect corners backed with good quality mesh net pocket. polish for better performance.

**KX-CBFS15** • Size - 32"x32"  
(Full Size)

**KX-CBMS15** • Size - 26"x26"  
(Medium Size)

**KX-CBSS15** • Size - 20"x20"  
(Small Size)

**REGULAR 1.5" BORDER**

- Carrom Board - Comes with 1.5" border and 3 MM plywood made of good quality wooden

**KX-CBFSE15 • Size - 32"x32"**
**KX-CBMSE15 • Size - 26"x26"**
**KX-CBSSE15 • Size - 20"x20"**

**CARROM BOARD STAND FOLDING**

- High Quality Carrom Stand which is compact, foldable and height adjustable.
- Made of Premium quality metal pipes, Rust Preventive coating and soft rubber base.
- Innovative Hydraulic design for smooth height adjustment and excellent load sharing

**KX-CBSF**
**CARROM BOARD STAND FOLDING SMALL**

- Made from combination of high quality metal pipe, iron rod & pvc.
- Next generation carrom board stand with compact design.
- Its unique design takes entire load on the metal pipe.
- Easily foldable & adjustable

**KX-CBSFS**



**CARROM MEN  
ACRYLIC LEISURE**  
KX-CMAL6 6MM



**CARROM MEN  
WOODEN LEGEND**  
KX-CMWL 8MM



**CARROM MEN  
WOODEN MASTER**  
KX-CMWM 8MM



**CARROM MEN  
PVC (PRINCE)**  
KX-CMPP8 8MM



**DYNASTY INJECTED WOOD  
CARROM COINS**  
KX-DIWCCS 8MM



**CARROM MEN  
ACRYLIC SPARK**  
KX-CMAM4 4MM



**CARROM MEN  
PVC (STRIKE)**  
KX-CMPS6 6MM



**CARROM STRIKERS MASTER**

- Master Striker acrylic weight as per international standard 15gm, Special cover case along with the striker
  - Size : 36x36x10MM
- KX-CSM



**CARROM STRIKERS TMQ**

- Smooth surface and excellent re-bounce, light weight, striker is made of pool ball material and waterproof
  - Size : 43x43x10MM
- KX-CST



**CARROM STRIKERS SUPREME**

- Smooth surface, light weight, waterproof
  - Size : 36x36x8MM
- KX-CSS

**KX-CPK500 500gm**
**CARROM POWDER KLUB**

- Club carrom powder contains 500gm
- Specialized powder use to allow easy sliding of coin and striker for any carrom board.
- This silky smooth formula does not clog and will not scratch or wear your board.

**COLOUR : WHITE**

**KX-CPK70 70gm**

**KX-CPK50 50gm**
**CARROM POWDER SUPER (DISCO)**

- This is the high grade carrom powder it not only gives smooth and soft sliding of the coin but also perfect grip over the striker it can be used in clubs, schools and collegs.
- Carrom powder are famous for making playing surface smooth and excellent re-bounce capabilities.

**COLOUR : PINK**

**KX-CPS20 20gm**

**KX-CPS10 10gm**

**KX-CPS5 05gm**

**CHESS BOARD**

**BOARD GAME**



**CHESS CONQUER GIFT SET**  
 KX-CQJ Size 11"  
 KX-CQS Size 14"



**CHESS BOARD**  
 KX-CQJ Size 11"  
 KX-CQS Size 14"

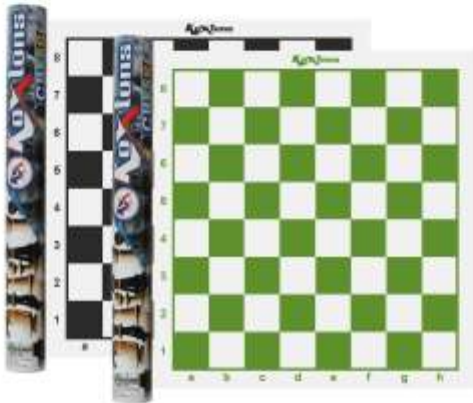

**CHESS ROLLON**  
 Size 17"x17"  
 KX-CHRO

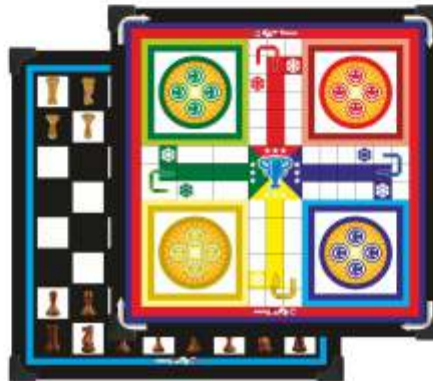

**CHESS & LUDO**  
 KX-CHLU



**CHESS BOARD HEAVY WOODEN SET**  
 KX-CBHWS



**CHESS BOARD 17"**  
 • Hardboard  
 KX-CHB17



**CHESS BOARD 15"**  
 • Hardboard  
 KX-CHB15



**CHESS BOARD 13"**  
 • Hardboard  
 KX-CHB13

**CHESSMEN TOURNAMENT**

- Made from high quality plastic, All pieces are made with high level precision. Sturdy 90 percent plastic filled chessmen, international Staunton chess pieces.

**KX-CHMT**



**CHESSMEN NAWAB**

**KX-CHMN**



**CHESSMEN SHAHENS SHAH**

**KX-CHMS**



**CHESSMEN ROYAL**

**KX-CMR**



**CHESSMEN CHAMPION**

**KX-CMC**



**CHESSMEN DELIGHT**

**KX-CMD**



**CHESSMEN KLUB**

**KX-CMK**



**KX-DB18 DIA18"    KX-DB16 DIA16"    KX-DB14 DIA14"    KX-DB12 DIA12"**

**DART BOARD**

- The board is made of plywood with cork surface.
- Make the best of this entertaining game and revel in this absorbing Activity.
- Content : 3 darts, 1 dart board with steel hook



**DART FLIGHT HEAVY  
KX-DFH3**



**CHINESE CHECKER WITH COIN**  
KX-CCWCS Size 13"  
KX-CCWCB Size 18"



**VISTA LUDO SNAKES & LADDER  
GIFT SET**  
KX-VLSJG Size 11"  
KX-VLSSG Size 14"

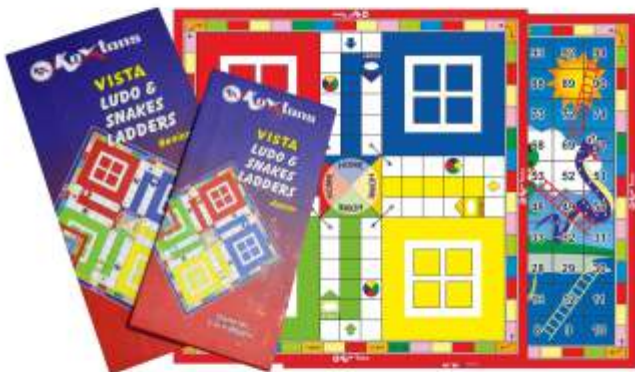

**VISTA LUDO SNAKES  
& LADDER**  
KX-VLSJ Size 11"  
KX-VLSS Size 14"



**TAMBOLA REGULAR**  
KX-TMBR

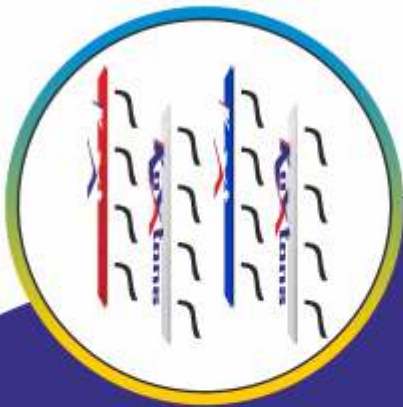

**LOTTO BOOK**  
KX-LB

**BOXING RING INTERNATIONAL LEVEL****KX-BRIL**

- Standard Size-24X24 Feet
- Playing Area-20X20 Feet
- Heavy Duty Padding
- Heavy Duty Cover.

- JSR Mat & cover.
- 32 MM Thick rope Set
- Extra Cushion Base.
- Heavy Steel Structure.





**KOXTONS WRESTLING DUMMY REGULAR**

Nt. Wt. 20kg, 40kg, 60kg, 80kg



**KOXTONS WRESTLING DUMMY PREMIUM**

Nt. Wt. 20kg, 40kg, 60kg, 80kg



**BOXING PUNCHING BAG CHALLENGER**

Non Tearing Fabric (PVC Coated)



**BOXING KIT JUNIOR**  
KX-BKJ



**BOXING KIT JUNIOR QUALITY**  
KX-BKJQ22

**CRICKET BAT ENGLISH WILLOW  
PLAYER EDITION**

- Hand crafted Elite Quality English Willow
- Includes padded bat cover
- Mid profile, light pick up
- Ready to play finish

**KX-EWPE**

**CRICKET BAT ENGLISH WILLOW  
TEST PRO**

- Hand crafted Elite Quality English Willow
- Includes padded bat cover
- Mid profile, light pick up
- Natural Finish

**KX-EWTP**

**CRICKET BAT ENGLISH WILLOW  
PRO PLAYER**

- Hand crafted crown quality.
- Includes padded bat cover mid profile.
- Light pick up natural finish.

**KX-EWPP**

**CRICKET BAT ENGLISH WILLOW  
TEST**

- Hand crafted quality. English Willow
- Includes padded bat cover
- Mid profile.
- Natural Finish.

**KX-EWT**



**CRICKET BAT ENGLISH WILLOW  
KX-2000**

- Hand crafted top
  - Quality English Willow
  - Mid profile
  - Weight range 2.7 – 2.9
- KX-EW2000**



**CRICKET BAT ENGLISH WILLOW  
KX-1000**

- Hand crafted English Willow
  - Weight range 2.7 – 2.9
- KX-EW1000**

**KASHMIRI WILLOW BAT**



**CRICKET BAT KASHMIR WILLOW  
LEGEND  
KX-CBKLD**



**CRICKET BAT KASHMIR WILLOW  
LEISURE  
KX-CBKLE**



**CRICKET BAT KASHMIR WILLOW  
XPRESS  
KX-CBKXS**

**CRICKET BAT**
**CRICKET EQUIPMENTS**

**CRICKET BAT KASHMIR WILLOW  
XPLD  
KX-CBKXD**



**CRICKET TENNIS BAT  
XPLD (Heavy Blade )  
KX-CTBXD**



**CRICKET TENNIS BAT  
XPRESS  
KX-CTBXS**



**CRICKET SET PLASTIC  
PRACTICE SIZE 5  
KX-CSPP5**



**CRICKET STUMP SET  
PLASTIC  
KX-CSSP**



**CRICKET BAT  
PLASTIC  
KX-CBP**



**CRICKET SET PLASTIC  
PRACTICE SIZE 3  
KX-CSPP3**

## CRICKET BALL

## CRICKET EQUIPMENTS



### TOURNAMENT WHITE

- High quality alum tanned leather
- Waterproof
- Portuguese cork wound with 100% wool
- Weight 155-160gms.

**KX-CLBTW FOUR PIECE**



### TOURNAMENT

- High quality alum tanned leather
- Waterproof
- Portuguese cork wound with 100% wool
- Weight 155-160gms.

**KX-CLBT FOUR PIECE**



### COUNTY

- High quality alum tanned leather
- Waterproof
- Indian cork wound with 100% wool
- Weight 155-160gms.

**KX-CLBC FOUR PIECE**



### KLUB

- High quality leather
- Waterproof
- Indian cork wound with 50% wool 50% nylon
- Weight 158-170gms.

**KX-CLBKL FOUR PIECE**



### PRACTICE

- Quality leather
- Indian cork wound with 100% wool
- Weight 150-170gms.

**KX-CLBP TWO PIECE**



### MAGNA

- Quality leather
- Indian cork wound with 100% wool
- Weight 150-170gms.

**KX-CLBM TWO PIECE**



**TENNIS BALL  
MAGNA  
KX-CTBM**



**TENNIS BALL  
RACER  
KX-CTBR**

**STUMP SET SPRING LOADED**

- Two wooden bails wooden stumps with iron base, and springs attached to the wickets, along with the stand two bails are provided

**KX-CSSL**

**TARGET STUMP**

- Plastic and Metal Target Stump with Spring, Spring back design allows stump to immediately retain original position.

**KX-CTS**

**NATURAL STUMP**

- Size : Standard.
- Material : Wooden.
- Color : Wooden

**KX-CSN**

**STUMP - DUCO**

- Made from strong premium wood for Long Lasting.
- Premium wood stumps duco painted.

**KX-CSD**

**STUMP SET - DUCO**

- 6 Pc Stump, 4 Bails with cover

**KX-CSSD**

**BAILS NATURAL**  
**KX-CBN**

**BAILS ECO**  
**KX-WSB**



**EMPEROR**

- High density foam and Traditional 7 cane construction for maximum shock absorption
- Reinforced Knee Protection (RKP)
- Wide side wing for added protection
- Cushioned straps for comfort fit
- Mesh and PU lined bolsters
- Sizes: J, Y RH & LH

**KX-CBLGE**

**ASPIRE**

- Elite quality pad in light weight series
- Breathable mesh lines bolsters
- Lightweight and flexible
- Sizes: M, Y RH & LH

**KX-CBLGA**



**XPRESS**

- Premium mesh internal bolsters
- Extended side wings
- Sizes: M, Y RH & LH

**KX-CBLGX**



**TEST**

- Wide side wing for added protection
- Cushioned straps for comfort fit
- Mesh and PU lined bolsters
- Sizes: M, Y RH & LH

**KX-CBLGT**

**TEST LITE**

- Wide side wing for added protection
- Cushioned straps for comfort fit
- Mesh and PU lined bolsters
- Wear resistant tatron instep
- Sizes: M, Y RH & LH

**KX-CBLGTL**

**COUNTY**

- Bothside wing for added protection
- Straps for comfort fit
- Foam Padded
- Wear resistant tatron instep
- Sizes: M, Y, B

**KX-CBLGC**

**KLUB**

- Bothside wings
- Cotton padded
- Wear resistant tatron instep
- Traditionally shaped cotton filled knee rolls
- Sizes: M, Y, B

**KX-CBLGK**





**CRICKET BATTING COMBO THIGH PAD EMPEROR**

- Adjustable waist strap ensures a comfort fit
- High density foam build
- High quality PVC material
- Towelled back with lightweight design

**KX-CBTPE**



**CRICKET BATTING THIGH PAD MOULDED**

- Premium quality Towel backing
- Light weight design
- Wide comfort straps
- A & Y RH & LH

**KX-CBTPM**

**CRICKET BATTING THIGH PAD SUPER**

- Towel backing and wide comfort straps
- Light weight dual density foam
- A & Y RH & LH

**KX-CBTPS**



**BEST QUALITY**

**CRICKET WICKET KEEPING  
GLOVES TEST  
KX-CWKG T**



**CRICKET WICKET KEEPING  
GLOVES TEST LITE  
KX-CWKG T L**



**CRICKET WICKET KEEPING  
GLOVES MAX LITE  
KX-CWKG M L**



**CRICKET WICKET KEEPING  
GLOVES MAX  
KX-CWKG M**



**CRICKET WICKET KEEPING  
GLOVES KLUB  
KX-CWKG K**



**CRICKET BATTING GLOVES  
EMPEROR**

- Premium quality leather palm for superior grip
  - 'dual' sided sweatband for player comfort ultralight foam
  - Airflow mesh gussets
  - Three piece thumb
  - M,Y,B LH & RH
- KX-CBGE**



**CRICKET BATTING GLOVES  
MAX LITE**

- Sheep leather glove
  - Airflow mesh gussets
  - Tri Flex fingers & Towelled wristband
  - Two piece thumb
  - Lightweight
  - M,Y,B LH & Rh
- KX-CBGML**



**CRICKET BATTING GLOVES  
ASPIRE**

- Sheep leather glove
  - Airflow mesh gussets
  - Two piece thumb
  - M,Y,B LH & RH
- KX-CBGA**



**CRICKET BATTING GLOVES  
XPRESS**

- Sheep leather glove
  - Airflow mesh gussets
  - Two piece thumb
  - M,Y LH & RH
- KX-CBGX**



**CRICKET BATTING GLOVES  
TEST**

- M,Y,B
- KX-CBGTL**



**CRICKET BATTING GLOVES  
TEST LITE**

- M,Y
- KX-CBGTL**



**CRICKET BATTING GLOVES  
COUNTY**

- M,Y,B
- KX-CBGC**



**CRICKET BATTING GLOVES  
KLUB**

- M,Y,B
- KX-CBGK**

**CRICKET HELMET**

**CRICKET HELMET MAXX**

Size Available

- Large
- Medium
- Small

**KX-CHM**

**CRICKET HELMET COUNTY**

Size Available

- Large
- Medium
- Small

**KX-CHC**

**CRICKET HELMET KLUB**

Size Available

- Large
- Medium
- Small

**KX-CHK**

**INNER GLOVES GOLD**

- Premium quality cotton inner gloves
- Comfortable feel
- Elastic wristband for comfort fit
- Excellent feel throughout the day
- Wide cotton cuff for the perfect fit
- Faster sweat absorption

**KX-IGG**

**INNER GLOVES ECONOMY**

- Premium quality cotton inner gloves
- Comfortable feel
- Excellent feel throughout the day
- Wide cotton cuff for the perfect fit
- Faster sweat absorption

**KX-IGE**
**INNER GLOVES**

**INNER GLOVES PREMIUM**

- Premium quality cotton inner gloves
- Comfortable feel
- Elastic wristband for comfort fit
- Excellent feel throughout the day
- Wide cotton cuff for the perfect fit
- Faster sweat absorption

**KX-IGP**

**INNER GLOVES SUPER**

- Premium quality cotton inner gloves
- Comfortable feel
- Excellent feel throughout the day
- Wide cotton cuff for the perfect fit
- Faster sweat absorption

**KX-IGSU**

**INNER GLOVES REGULAR**

- Premium quality cotton inner gloves
- Comfortable feel
- Excellent feel throughout the day
- Wide cotton cuff for the perfect fit
- Faster sweat absorption

**KX-IGR**

**INNER GLOVES STAR**

- Premium quality cotton inner gloves
- Comfortable feel
- Excellent feel throughout the day
- Wide cotton cuff for the perfect fit
- Faster sweat absorption

**KX-IGST**



**CRICKET BAT GRIP  
CAMEO  
KX-CBGCO**



**CRICKET BAT GRIP  
OCTO BANGAL  
KX-CBGOB**



**CRICKET BAT GRIP  
SCALE  
KX-CBGS**

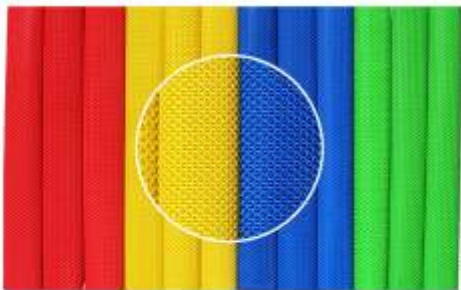

**CRICKET BAT GRIP  
OCTOPUS  
KX-CBGO**



**CRICKET BAT GRIP  
SUPREME PREMIUM  
KX-CBGSP**



**CRICKET BAT GRIP  
SUPREME ECO  
KX-CBGSE**



**CRICKET BAT GRIP  
PLAIN  
KX-CBGP**



**CRICKET SCORE BOOK**

**KX-CSB40** 40 Innings  
**KX-CSB20** 20 Innings

**CRICKET ABDOMINAL GUARD ECONOMY**

- Strong plastic in traditional guard
- Border bound with foam casing stuffed with fluffed cotton

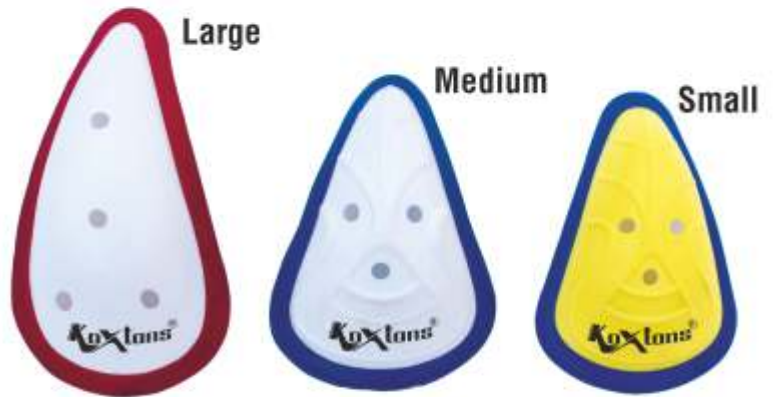
**KX-CAGEY**

**CRICKET ABDOMINAL GUARD PREMIUM**

- Strong plastic in traditional guard
- High impact resistant poly protector
- Traditionally shaped & padded guard
- Provides optimum grain protection
- Pin less buckle system

**KX-CAGPL** Large  
**KX-CAGPM** Medium  
**KX-CAGPS** Small

**CRICKET BAT MALLET**

- It is durable with two seamless heads
- Comforts wrist and provides easy grip to hold the mallet
- Design to make bat knocking more easy
- Perfect for knocking
- Weight : 180gm

**KX-CBM**



**CRICKET GRIP CONE  
BRASS COLLAR**  
**KX-CGCBC**



**CRICKET GRIP CONE  
STEEL COLLAR NATURAL**  
**KX-CGCSCN**



**CRICKET GRIP CONE STEEL  
COLLAR PAINTED**  
**KX-CGCSCP**



**CRICKET BATTING  
TEE**  
**KX-CBT**

**MONSTER**

- Size 40"X14.5"X14.5"

**KX-CKBM****IMPRESSIVE**

- Size 36"X14.5"X14.5"

**KX-CKBI****ULTIMATE**

- Size 36"X14"X14"

**KX-CKBU**

**PROFESSIONAL**

- One big compartment
- 2 side pockets to fit in full size cricket bats
- 2 front pockets for all accessories
- Made from durable textured material
- Padded back straps for easy carry
- Size 25.5"x14"x12"

**KX-CKBP**

**DUFFLE**

- One big compartment
- 1 side pockets to fit in full size cricket bats
- 1 front pockets for accessories
- Made from durable textured material
- Padded back straps for easy carry
- Size 25.5"x10"x8.5"

**KX-CKBD**

**PRO MAX**

- Made from durable textured material
- 1 side pocket
- Size 37"x12"x12"

**KX-CKBPM**

**MAX**

- Made from durable textured material
- 1 side pocket
- Size 39"x12"x12"

**KX-CKBMX**





**GYM BAG CLASSIC**

- Made from durable textured material
- 2 side round pocket
- Size 20"x10"x10"

**KX-GBC**

**GYM BAG ECO**

- Made from durable textured material
- 2 side round pocket
- Size 16.5"x9"x9"

**KX-GBE**



**GYM BAG ECONOMY**

- Made from durable textured material
- 2 side round pocket
- Size 13.5"x9"x9"

**KX-GBEY**





**CRICKET CAGE MOVABLE**  
KX-CCM

**CRICKET NET NYLON  
MACHINE KINTTED**

- KX-CNN100 (1mm THICKNESS)
- KX-CNN200 (2mm THICKNESS)
- KX-CNN250 (2.5mm THICKNESS)

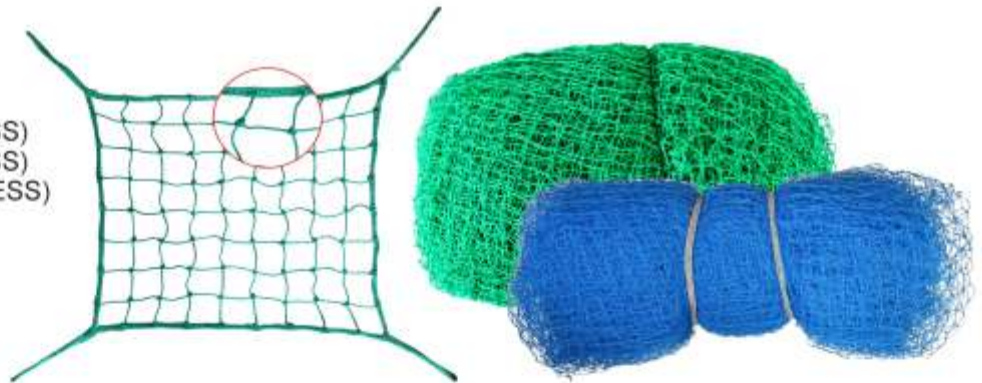

**PITCH ROLLER**  
• 2 Tonn Capacity  
KX-CPR200



**PITCH ROLLER**  
• 1 Tonn Capacity  
KX-CPR100



**PITCH ROLLER**  
• 0.5 Tonn Capacity  
KX-CPR50

## WEIGHT LIFTING BARS

## WEIGHT LIFTING & FITNESS

### OLYMPIC WEIGHT LIFTING BAR

- Olympic Weight Lifting Bar is made up of premium quality material for strength and flexibility.
- Designed and engineered for balance and long lasting performance.
- This bar is durable, easy to install, un-breakable and 7 feet in length.
- Chromed Finish
- Includes collars

<b>KX-OBE</b>	17 Kg
<b>KX-OBR</b>	20 Kg
<b>KX-OBP</b>	25 Kg



### OLYMPIC WEIGHT LIFTING BAR

**KX-OWLB6**



**KX-OWLB5**



**KX-OWLB4**



**KX-OWLB3**



### WEIGHT LIFTING ROD CHROME

Premium (28mm)

Club (25mm)

6'

Practice (23mm)



**KX-RCPM6**

KX-RCC6

5'



**KX-RCPM5**

KX-RCC5

KX-RCP5

4'



**KX-RCPM4**

KX-RCC4

KX-RCP4

3'



**KX-RCPM3**

KX-RCC3

KX-RCP3

### WEIGHT LIFTING ROD CURL CLUB 25mm

**KX-RCURLC5**



**KX-RCURLC4**



**KX-RCURLC3**



**WEIGHT PLATES 4 HOLE**

**KX-WP4H**

- Available weight 2.5, 5.0, 7.5, 10.0, 15.0, 20.0, 25.0 Kg



**WEIGHT PLATES 3 HOLE**

**KX-WP3H**

- Available weight 2.5, 5.0, 7.5, 10.0, 15.0, 20.0, 25.0 Kg

**WEIGHT PLATES - STEERING PATTERN**

**KX-WPSP**

- Available weight 2.5, 5.0, 7.5, 10.0, 15.0, 20.0, 25.0 Kg



**WEIGHT PLATES IRON - CHROME**

**KX-WLPC**

- Available weight 1.0, 2.0, 2.5, 3.0, 4.0, 5.0, 7.5, 10.0, 15.0, 20.0, 25.0 Kg



**WEIGHT PLATES BLACK - RUBBERIZED**

**KX-WPB**

- Available weight 1.0, 2.0, 2.5, 3.0, 4.0, 5.0, 7.5, 10.0, 15.0, 20.0, 25.0 Kg

## DUMBBELLS

## WEIGHT LIFTING & FITNESS



### DUMBBELL CHROME

- Attractive, highly reflective set of dumbbells
- Ergonomic knurled handles for comfort
- Solid steel heads are chip-resistant

#### KX-WDC

- Available weight  
2.5, 5.0, 7.5, 10.0, 15.0, 20.0 Kg

### DUMBBELL HEXAGON

- Made from solid cast iron with a 6-sided anti-roll design and encased in virgin rubber, this dumbbell is stylish as it is durable.
- A combination of gym equipment for the perfect workout.
- Highly durable and long lasting

#### KX-WDH

- Available weight  
2.5, 5.0, 7.5, 10.0, 15.0, 20.0 Kg



### DUMBBELL STRENGTH

- Protective rubber coating against corrosion and scratches and for floor protection as well.
- Ribbed, fully chromed steel handle/knurled.

#### KX-WDS

- Available weight  
2.5, 5.0, 7.5, 10.0, 15.0, 20.0 Kg



### DUMBBELL PVC

- Cast iron dumbbell coated with vinyl.
- Ideal for strengthening muscles, weight training firm and tighten upper body.
- Vinyl coating prevents from damaging the floor

#### KX-DPVC



### DUMBBELL ROD

- (25mm & 23mm)  
KX-DR25 25mm  
KX-DR23 23mm



### STAR NUT

**DUMBBELL RACK (3 TIER) 4X2**

- Heavy gauge Pipe Quality.
- High strength steel tube Square tube precision welds and internally lubricated cables.

**KX-DR3T**

**DUMBBELL RACK ( 2 TIER) 4X2**
**KX-DR2T**

**DUMBBELL RACK MEGNUM**
**KX-DRM**

**VERTICAL  
DUMBBELL STAND**
**KX-VDS**

**DUMBBELL  
RACK TRIANGLE**
**KX-DRTE**

**DUMBBELL RACK ECONOMY (2X2)**
**KX-DRE**

**OLYMPIC BAR STAND**  
KX-OBS



**PLATE TROLLEY WITH 2 PC  
ROD HOLDER**  
KX-PTRH



**PLATE RACK 4X2**  
KX-PR4



**ADJUSTABLE SQUAT RACK**  
KX-ADSR

**KETTLE BELL**

- Due to the shape of the kettlebells, many exercises can be performed with better form using kettle bells, many also prefer using kettle bells to perform certain athletic moves.

**KX-KBCI****SUSPENSION RING**

- Includes 2 gymnastic rings with straps and adjusting buckles.
- The rings are made of textured, grippable PC plastic (to reduce slippage associated).
- Takes 5 minutes to set up, use and adjust providing you with a great home gym substitute.
- Unlimited body weight exercises

**KX-SSR**





**PUSH-UP BAR REGULAR**  
KX-PUBR



**PUSH-UP BAR S SHAPE**  
KX-PUBS



**PUSH-UP BAR U- SHAPE**  
KX-PUBU



**PUSH-UP BAR**  
KX-PUBP



**PUSH-UP BAR PVC**  
KX-PUBP



**POWER GRIP PRO**  
KX-HGPRO



**POWER GRIP CHAMPION**  
KX-HGCH



**POWER GRIP KLASSIC**  
KX-HGK



**POWER GRIP PREMIUM**  
KX-HGP

**FITNESS TUBE**

- Extra Heavy (Black)
- KX-FTXH**

**FITNESS TUBE**

- Heavy (Red)
- KX-FTH**

**FITNESS TUBE**

- Medium (Orange)
- KX-FTM**

**KOXTONS FITNESS TUBE**

- Light (Yellow)
- KX-FTL**

**SOFT EXPENDER**

- Heavy (Red)
- KX-SEHR**

**SOFT EXPENDER**

- Medium (Orange)
- KX-SEMO**

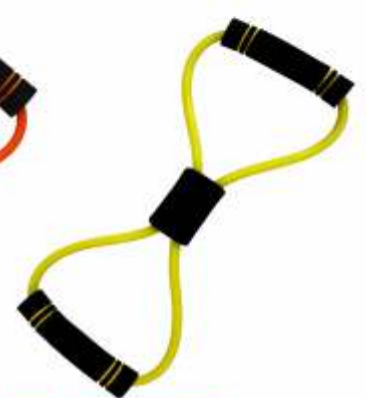
**SOFT EXPENDER**

- Light (Yellow)
- KX-SELY**

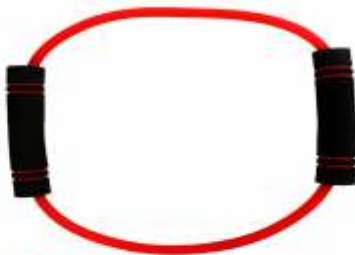
**O-EXPENDER**

- Heavy (Red)
- KX-OEH**

**O-EXPENDER**

- Medium (Orange)
- KX-OEM**

**O-EXPENDER**

- Light (Yellow)
- KX-OEL**

**WEIGHT JACKET - CLUB**

- Weight jacket made of strong polyester fabric with 10 pockets and who adjustable straps for a perfect fitting.

**KX-WJC10P 10kg**



**FITNESS BAND**

- KX-FBLY Yellow
- KX-FBLO Orange
- KX-FBLR Red



**YOGA MAT**

- Made in India Product.
- Non toxic light weight.
- Easy handling.

- KX-YMP4 04mm Thickness
- KX-YMP6 06mm Thickness



**DIP STAND WALL MOUNTED**

- Designed to be easy to Install Solid Grip
- Strong Heavy Duty Material
- For Upper Body Conditioning

**KX-DSWM**

**HANGING ROD DOUBLE**

- Strong heavy duty steel material and comfy foam grips.
- Simple assembly and portable.

**KX-HRD**
**HANGING ROD SINGLE**

- Non-Slip Foam Grip – Each heavy-duty steel bar is covered in soft, yet durable foam to improve your grip strength and comfort while also minimizing wrist strain.

**KX-HRS**

**WRIST ROLLER**

- Made up of high grade carbon-steel rod for durability, nylon rope for strength and foam grip for painless better grip.
- Without weight

**KX-WR**

**HANGING ROD WITH CHAIN**

- Made of heavy steel chain and heavy rod fixed with it and foam cushions for extra cushion and comfort for hanging.

**KX-HRC**



**ANKLE WEIGHT**

- Ankle weight for a perfect training.
- Made from a heavy duty imported fabric.
- Available in different weight.

<b>KX-AW05</b>	500gm (Pair)
<b>KX-AW10</b>	1kg (Pair)
<b>KX-AW15</b>	1.5 kg (Pair)
<b>KX-AW20</b>	2.0 kg (Pair)



**WEIGHT LIFTING BELT**

- Weight lifting belt is made up of high quality fabric with EP inside along with the nylon belt with Velcro.
- Our belts are heavily double stitched for maximum durability.

<b>KX-WLBFS</b>	Small
<b>KX-WLBFM</b>	Medium
<b>KX-WLBFL</b>	Large
<b>KX-WLBFXL</b>	Extra Large



**BALANCING BOARD**

- This wobble board provides a stable rehab and physical therapy system for anyone trying to overcome an injury.
- KX-BB**



**WAIST TWISTER**

- Effectively burns calories and combines the benefits of aerobic exercise with reflexology.
- The plastic material of this twister firmer your forearms, sleeves and fingers and provides a good foot grip.
- For an amazing body shape, make it a habit of using it daily.

**KX-WT**



**AB WHEEL**

- Comfortable non-slip foam grips for stability and control. It also comes with two non-skid wheels for added stability and smooth functioning.
- Easy to assemble, our ab roller is suitable for travelling.

**KX-ABW**





**GYM BALL**

**KX-GB85** 85cm

**KX-GB75** 75cm

**KX-GB65** 65cm

**KX-GB55** 55cm

- Made with thick and durable PVC materials, easy to clean and carry.
- Large balance ball promotes strength, agility, and balance
- Safe Durable and Easy to Use
- Material: Rubber



**MEDICINE BALL - RUBBER**

- Medicine ball made of Rubber compound. Increases the intensity of a variety of exercises and strengthen core muscles.

<b>KX-MBR1</b>	1 Kg
<b>KX-MBR2</b>	2 Kg
<b>KX-MBR3</b>	3 Kg
<b>KX-MBR4</b>	4 Kg
<b>KX-MBR5</b>	5 Kg



**MEDICINE BALL STAND**  
**KX-MBS**



**BRIEF SUPPORTER OPTIMA**

- Made of 100% pure cotton
- Gym supporter premium genuine and high quality elastic for better grip and support.
- Ideal for all fitness activities
- Double fabric pouch

KX-SSO S/M/L  
KX-SSOX XL/XXL



**BRIEF SUPPORTER FREEDOM**

- Superior quality design for maximum durability.
- Gym supporter premium genuine and high quality elastic for better grip and support.
- Ideal for all fitness activities
- Double fabric pouch

KX-SFS S/M/L  
KX-SFXL XL/XXL



**BRIEF SUPPORTER ULTIMA**

- Made of 100% pure cotton
- Gym supporter premium genuine and high quality elastic for better grip and support.
- Ideal for all fitness activities
- Double fabric pouch

KX-SSU S/M/L  
KX-SSUX XL/XXL



**BRIEF SUPPORTER LEISURE**

KX-SSL S/M/L  
KX-SSLX XL/XXL



**BRIEF SUPPORTER KLUB**

KX-SSK S/M/L  
KX-SSKX XL/XXL



**BRIEF SUPPORTER KLUB**

12 Pcs Packing



4 way stretch

**DELUXE**

- 4 Way Stretch
  - Perfect Fit
  - Design for maximum support
- KX-KCDL**



**ULTRA**

- Improves Stag Nation
  - Improves Blood Circulation
  - Aids achy joints due to aging
- KX-KCUT**



**ULTIMA**

- It is made from cotton lycra
  - Sport Adjustable
  - Enhanced Comfort
- KX-KCUL**



**OPTIMA**

- 4 Way Stretch
  - Perfect Fit
  - Cotton Fabric
  - Improves Blood Circulation
- KX-KCBO**



**SAGA**

- Design to support the limbs & joints, pain & inflammation during injury
  - Provide therapeutic warmth and adequate compression.
  - Easy to wear & product is latex free
- KX-KCSS KX-KCSSXL**

**SAGA (XL)**

- Design to support the limbs & joints, pain & inflammation during injury
- Provide therapeutic warmth and adequate compression.
- Easy to wear & product is latex free



**ACTIVE**

- It is made from cotton.
  - Universal Size
  - Enhanced Comfort
- KX-KCA  
KX-KCAXL**



**MAGNA**

- It is made from cotton, nylon.
  - Universal Size
  - Enhanced Comfort
- KX-KCBM**



**ECONOMY**

- Universal Size
  - Enhanced Comfort
- KX-KCE**



**PADED**

- Universal Size
  - Enhanced Comfort
- KX-KCPD**





**ANKLET SAGA**  
KX-ASCS



**ANKLET MAGNA**  
KX-ABCM



**ANKLET ECONOMY**  
KX-APCE



**ELBOW SUPPORT DLX GOLD**  
KX-ESDG



**ELBOW SUPPORT CLASSIC**  
KX-ESC



**ELBOW SUPPORT SUPER GOLD 16"**  
KX-ESSG16



**ELBOW SUPPORT SUPER**  
KX-ESS



**ELBOW SUPPORT DELUXE**  
KX-ESD



**ELBOW SUPPORT PLUS**  
KX-ESP



**HEAD BAND**  
KX-HB



**CAPTAIN ARM BAND**  
KX-CAB



**SWEAT BAND LONG**  
KX-SBL



**SWEAT BAND REGULAR**  
KX-SBR



**WRIST BAND ECO**  
KX-WBE



**MATRIX THUMB SUPPORT WRIST BAND**

- Made With High Quality Knitted Elastic.
- Improves blood circulation, supports thumb, palm and wrist, used for muscular pain.
- Support Thumb With Wrist.
- High Quality stretch matreal and velcrow perfect gripping.

KX-MTSWB

**UNIVERSAL DOUBLE SUPPORT WRIST BAND**

- Comfortable for exercise
- Protect Wrist (reduce wounds/muscle injuries)

KX-UDSWB



**BOXING BANDAGE**

- Material Hand wraps made from durable, stretchable elastic cotton material with standard size wide hand wrap strap wraps.
- In-Box Contents: 1 Pair of Boxing Hand Wrap.
- Deal for all professionals, cardio classes, men, women, youths and all games Boxing, Training, muaythai, karate, judo etc.

KX-BBG

**MULTIPURPOSE BAND**

- Made with high quality elastic material, durable wraps allow each user to wrap them to their exact preference, ensuring a comfy, personalized feel. Perfect for gym, squats, power lifting, fitness, cross fit, training, weightlifting, strength training, bodybuilding etc.

KX-MPB





**LEGEND**  
KX-SGLE



**VENTORE**  
KX-SGV111



**FIGHTER**  
KX-SGF200



**POWER**  
KX-SGP



**LEISURE**  
KX-SGLI



**TRAINING**  
KX-SGT



**XPRESS**  
KX-SGXP



**ECONOMY**  
KX-SGEC

**POST MOVABLE - PREMIUM (Spring Loaded System)**

- Basketball pole set made of heavy duty steel tube structure with Spring Loaded System for height adjustment at different levels.
- Comes with heavy base trolley having designed to hold heavy weighted batteries for stability of the post with quality wheels.

**KX-BBPMP****INSTALLED AT  
INTERNATIONAL SCHOOL**



**BASKET BALL POST MOVABLE-CLUB (Manual Jack System)**

- Post made in heavy duty steel structure with height adjustment by manual jack system.
- Comes with heavy base trolley having designed to hold heavy weighted batteries for stability of the post with quality wheels.

KX-BBPMC

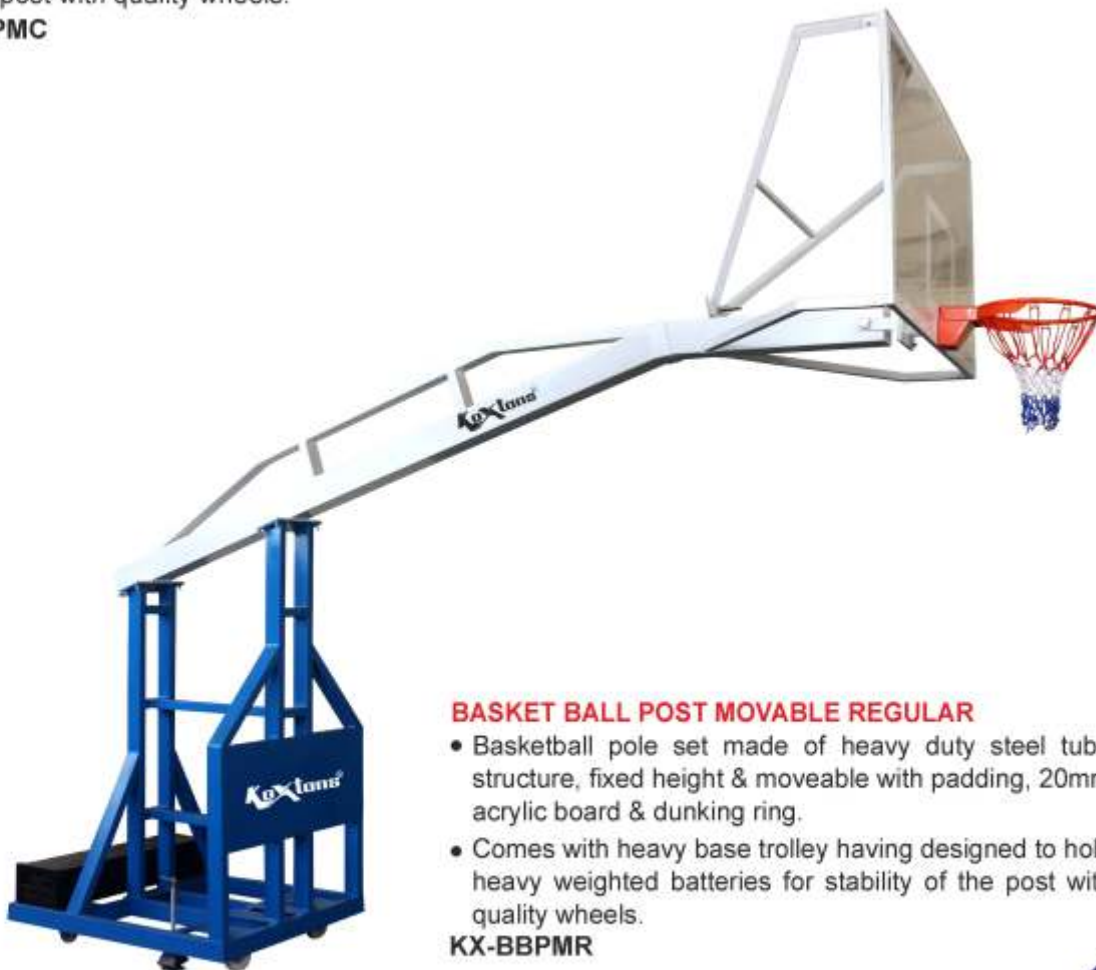

**BASKET BALL POST MOVABLE REGULAR**

- Basketball pole set made of heavy duty steel tube structure, fixed height & moveable with padding, 20mm acrylic board & dunking ring.
- Comes with heavy base trolley having designed to hold heavy weighted batteries for stability of the post with quality wheels.

KX-BBPMR

**BASKET BALL POST MOVABLE-ECONOMY (Fixed Height)**

- Made of heavy duty 6" round steel pipe with 20 mm Board and Ring.
- Fixed type with heavy trolley at base and wheels for easy transportation.

**KX-BBPME****BASKETBALL POST 2 IN 1****KX-BBP21**

**BASKETBALL POST FIXED 6"**

- Basketball post fixed 6" square pipe with height adjustment adjust system.
- 20mm Acrylic Board and Dunking Ring
- Height can be adjusted from 6 ft to 10 ft.

**KX-BPF6**

**BASKETBALL POST FIXED REGULAR**

- Made of heavy duty 8" & 6" round steel pipe with 3.2 mtr and 2.2 mtr extension fixed in ground.
- It comes along with 20 mm Acrylic Board & Dunking Ring.

Competition (8" pipe)

**KX-BBPF32**
**KX-BBPF22**

Regular (6" pipe)

**KX-BBPR32**
**KX-BBPR22**
[www.koxtons.com](http://www.koxtons.com)

**BASKETBALL POST FIXED (SQUARE PIPE)**

- Made of heavy duty 6" square steel pipe with 20mm acrylic board.

**KX-BBFP32****KX-BBFP22****BASKETBALL POST - JUNIOR**

- Made of heavy duty 3" round steel pipe with wooden board and junior basketball ring along with different height adjustment system.

**KX-BBPJA**





**BASKETBALL POST - WALL MOUNTED WITH 20MM ACRYLIC BOARD**  
KX-BBWM



**BASKETBALL BACK BOARD- ACRYLIC**

- Comes with heavy steel angle frame and standard size of 180cm x 105cm perfectly marked with high quality paint as per basketball federation.

KX-BBBA18	1 PAIR
KX-BBBA20	1 PAIR
KX-BBBA25	1 PAIR
KX-BBBA30	1 PAIR

**BASKETBALL DUNKING RING REGULAR 3 SPRING**

- Dunking Ring made of 20 mm steel tube with two flexible spring system & solid 4 mm thick back support plate for extra durability & strength.

**KX-BBDRR3**

**BASKETBALL DUNKING RING REGULAR 2 SPRING**

- Dunking Ring made of 20 mm steel tube with two flexible spring system & solid 4 mm thick back support plate for extra durability & strength.

**KX-BBDRR2**

**BASKETBALL DUNKING RING PREMIUM**

- Premium ring made of 20 mm solid steel tube with solid back support plate for extra durability and strength.

**KX-BBDRP**

**BASKETBALL DUNKING RING SCHOOL**

- Made of 19 mm hollow steel tube with solid back support plate for extra durability & strength.

**KX-BBDRS**

**BASKETBALL DUNKING RING ECONOMY**

- Made of 16/12 mm solid steel tube with solid back support plate for extra durability and strength.

**KX-BBDRE16**
**KX-BBDRE12**

**BASKETBALL DUNKING RING JUNIOR**
**KX-BBDRJ**

**FOOTBALL GOAL POST  
STEEL PREMIUM  
KX-FGPSP**



**FOOTBALL GOAL POST- MOVABLE (STEEL)**

- Football Goal Post – Movable (Steel) made as per standard specification in 4" and 3" round steel pipe Box Shape.
- Comes along with wheels for smooth shifting.

**KX-FGMS8011 4" Movable**  
**KX-FGMS8013 3" Movable**



**FOOTBALL GOAL POST- FIXED (STEEL)**

- Football Goal Post – Movable (Steel) made as per standard specification in 3" & 4" round steel pipe.

**KX-FGFS8010 4" Fixed**  
**KX-FGFS8012 3" Fixed**



**FOOTBALL GOAL POST  
PVC- REGULAR**

- Football Goal Post PVC- Regular is foldable & easy to carry, made of PVC pipe.
- Size : 12ft x 6 ft  
KX-FGPR126

**FOOTBALL GOAL POST  
MINI**

- Specially designed for kids made in 48 mm steel round pipe, powder coated with high grade net.
- Portable to carry any where and to install.
- Size : 4 ft x 3 ft  
KX-FGPM43

**HOCKEY GOAL POST MINI**

- Specially designed for kids made in 25 mm steel round pipe, powder coated with high grade net.
- Portable to carry any where and to install.
- Size : 2 ft x 3 ft  
KX-HGPM23





**HOCKEY GOAL POST- MOVABLE (STEEL)**

- Hockey Goal Post – Movable (Steel) made as per FIH standard specifications.
- All steel construction 70mmx50mm rectangular pipe and backboard made of strong wood.
- Its is a movable Hockey Goal Post.

**KX-HGFS8030** Fixed  
**KX-HGMS8031** Movable

**HANDBALL GOAL POST- MOVABLE (STEEL)**

- Handball Goal Post – Movable (Steel) made as per standard specification & regulation of IHF.

**KX-HBMS8021**

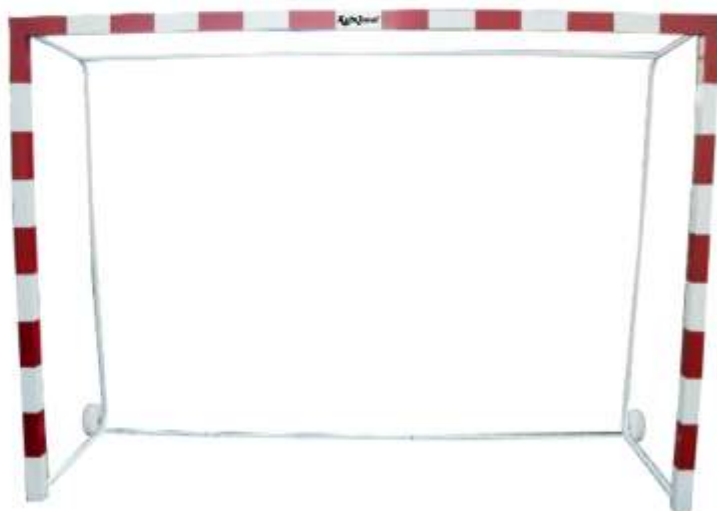

**HANDBALL GOAL POST- FIXED (STEEL)**

- Handball Goal Post- Fixed (Steel) made as per standard specification & regulations of IHF.

**KX-HBFS8020**



**VOLLEYBALL POST  
TELESCOPIC MOVABLE**

- Made as per standard specification.
- Made of heavy duty 75 mm Round steel pipe with Telescopic System for height adjustment.
- It comes with heavy batteries for better sustain.

**KX-VBPTM**

**VOLLEYBALL GOAL POST  
TELESCOPIC- FIXED**

- Made as per standard specification.
- Made of heavy duty 75 mm round steel pipe with telescopic system for height adjusting.

**KX-VBPTF**

**VOLLEYBALL POST  
ADJUSTABLE - MOVABLE**

- Made of 3" x 3.5" round steel pipe with external ratchet height adjustment system, fibre weight with non tearing cover & wheels for easy movement.

**KX-VBPM8062**

**VOLLEYBALL POST FIXED**

- Volleyball post Adjustable and Fixed made of 3" X 3.5" round steel pipe with external ratchet & height adjustment system.

**KX-VBPF8060**





**BADMINTON POST  
TOURNAMENT DELUXE**

- Made as per standard specification.
  - Base made of solid steel with sturdy wheel for easy movement.
  - Weight each side
- KX-BPMTD**

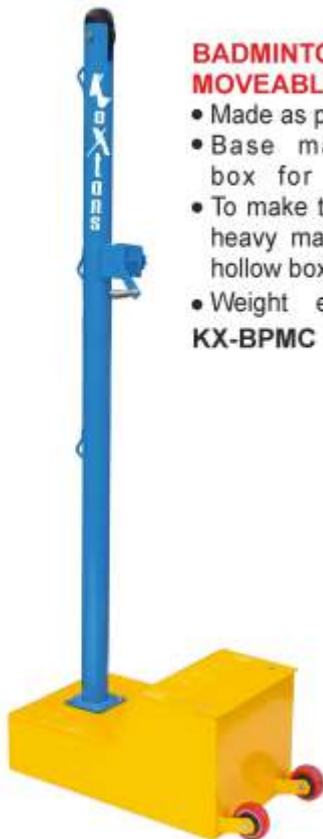

**BADMINTON POST  
MOVEABLE TOURNAMENT**

- Made as per standard specification.
  - Base made of solid steel with sturdy wheel for easy movement.
  - Weight each side
- KX-BPMT**



**BADMINTON POST  
MOVEABLE COMPETITION**

- Made as per standard specification.
  - Base made of hollow steel box for easy transportation.
  - To make the base sturdy sand/any heavy material can be filled in the hollow box.
  - Weight each side
- KX-BPMC**



**BADMINTON POST  
MOVABLE- 50 KG**

- Made as per standard specification with heavy duty 46 mm square steel pipe fixed to 4" cylindrical base pipe
  - Weight 50kg each side
- KX-BPM50**

## BADMINTON POST

## GOAL POST | POLES



### BADMINTON POST MOVABLE 100 KG

- Made as per standard specification with heavy duty 46 mm square steel pipe
  - Weight 100kg each side
- KX-BPM100**

### BADMINTON POST MOVABLE 80 KG

- Made as per standard specification with heavy duty 46 mm square steel pipe fixed to 8" cylindrical base pipe
  - Weight 80kg each side
- KX-BPM80**



**CLUB**  
KX-BPCF8001

**BADMINTON POST FIXED**

**REGULAR**  
KX-BPRF8002



**KHO KHO POST - STEEL**  
KX-KKPS



**KHO KHO POST WOODEN**  
KX-KKPW





**REFEREE CHAIR  
VOLLEY BALL (SQUARE PIPE)**

- All steel construction with metal and foam padded seat.
- KX-RCVS3**



**VOLLEYBALL REFEREE  
STAND**

- All steel construction with metal sheet
- KX-RCVRS**



**REFEREE CHAIR  
VOLLEY BALL**

- All steel construction with metal
  - Height : 7ft.
- KX-RCV3**



**REFEREE CHAIR - TENNIS**

- KX-RCT1** Fixed
- KX-RCTF** Foldable



**REFEREE CHAIR  
BADMINTON**

- All steel construction with metal and foam padded seat.
  - Height : 6ft.
- KX-RCB**

## LAWN TENNIS POST

## GOAL POST | POLES

### LAWN TENNIS POST MOVABLE COMPETITION

- Lawn Tennis Post Movable Competition made of 80 mm square steel tube with heavy duty ratchet for tightening the net and 6" wheels for easy movement.

**KX-LTPMC**

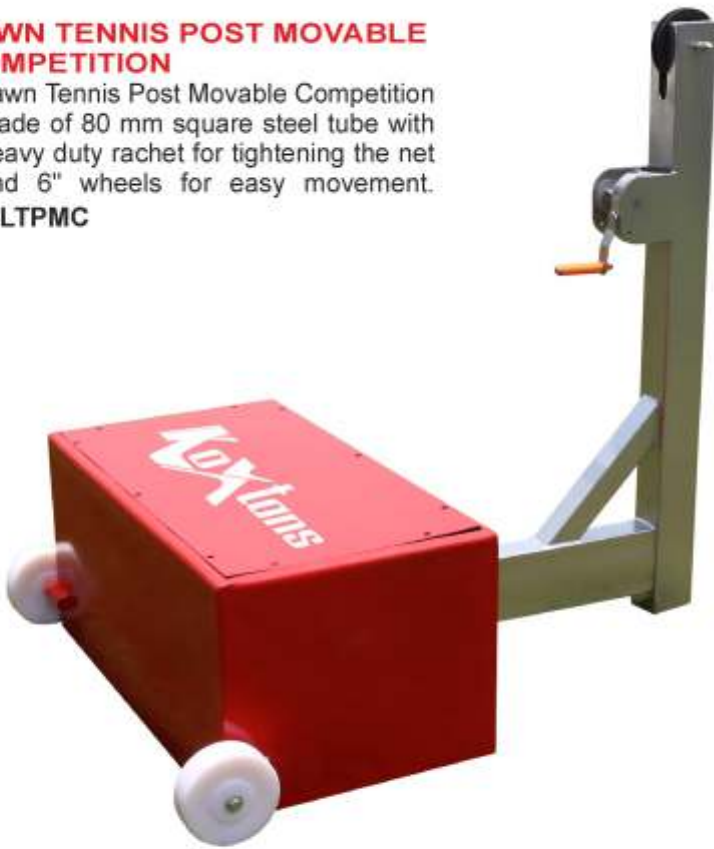

### LAWN TENNIS POST MOVABLE TOURNAMENT

- Lawn Tennis Post Movable Tournament made of 100 mm round steel pipe with ratchet, fiber weight & wheels for easy movement.

**KX-LTPMT240**





**LAWN TENNIS POST FIXED COMPETITION (BRASS RATCHET)**

- Lawn Tennis Post made of 80 mm square steel pipe with internal brass ratchet, provided without or with sleeves for easy installation.

**KX-LTPFC8053**



**LAWN TENNIS POST FIXED CLUB**

- Lawn Tennis Post Fixed - Club is made of 80 mm square steel pipe with ratchet for easy installation.

**KX-LTPFC8051**



**TENNIS CENTER NET STRAP**

**KX-TCNS**



**NETBALL POST - PORTABLE & MOVABLE**

- Netball Post made of 50 mm round steel pipe upright and ring with adjustable height fixing option.
- Sturdy base with wheel for easy transportation.

**KX-NBPM8064**



**NETBALL POST - FIXED**

- Netball Post set with height adjustment to 8 ft, 9 ft & 10 ft.
- Made of 50 mm round steel pipe.

**KX-NBPF**

**HAND BALL NET NYLON HAND KNITTED**

- 100% nylon net hand knitted available in 1mm, 2mm & 3mm thickness official size.

**KX-HBN401** 1mm Thickness  
**KX-HBN402** 2mm Thickness  
**KX-HBN403** 3mm Thickness

**HAND BALL NET NYLON MACHINE KNITTED**

- 100% nylon net machine knitted available in 1mm, 2mm & 3mm thickness official size.

**KX-HBN405** 2mm Thickness  
**KX-HBN406** 3mm Thickness

**HOCKEY GOAL NET NYLON HAND KNITTED**

- Box type all single blocks 100% nylon net hand knitted
- Available in 1mm, 2mm & 3mm thickness official size.

**KX-HGN501** (1mm THICKNESS)  
**KX-HGN502** (2mm THICKNESS)  
**KX-HGN503** (3mm THICKNESS)

**HOCKEY GOAL NET NYLON MACHINE KNITTED**

- Box type all single blocks 100% nylon net machine knitted
- Available in 1mm, 2mm & 3mm thickness official size.

**KX-HGN504** (2mm THICKNESS)  
**KX-HGN505** (3mm THICKNESS)

**TENNIS NET NYLON HD CANVAS TETRON**

- Extra thick twisted 30 meshes single dori with Vinyl tape and pvc coated wire (with carry bag)

**KX-TN602**

**TENNIS NET COTTON HEAVY DUTY TETRON**

- Thick Twisted 30 Meshes all double with Tetron Tape (with carry bag)

**KX-TN601**

**TENNIS NET WIRE**

- Heavy duty tennis net wire PVC Coated.
- Length 15M Thickness 4mm

**KX-TWIRE**



**PRO SPEED**

- Bigger wheels size
- High speed semi precision ball bearings with 60mm anti skid vinyl wheel
- Toe stoppers for greater control.
- High gripping wheels
- Available in attractive colors

**KX-RSBS**



**SUPER SPRINTER**

- Bigger wheels size
- High speed semi precision ball bearings with 60mm anti skid pvc wheel
- Toe stoppers for greater control.
- High gripping wheels
- Available in attractive colors

**KX-RSSS**

**SPRINTER**

- Zinc plated powder coated roller skates
  - Sprinter wheels 55mm diameter with brake PVC flap and straps
  - Size 3-10 us (expandable)
  - Ideal for 6 years & above
- KX-RSS**

**XPLOD**

- Light weight fiber chassis and adjustable in size (adjustment range min. 21cms max 25 cms).
- High speed semi precision ball bearings with 60mm anti skid rubber wheel.
- Toe stoppers for greater control.
- Lightweight design allows child to skate more freely.
- This classic adjustable skate is a great way to get started! Great for indoors and outdoors.

**KX-RSX**

## ROLLER SKATES

## ROLLER SKATES ACCESSORIES



### BOOSTER

- Zinc plated powder coated roller skates
- Sprinter wheels 55mm diameter
- PVC flap and straps
- Size 3-5 us (expandable)
- Ideal for 3 to 7 years & above

KX-RSB



### PROTECTIVE SET

- Protective pad designed for safety and comfort
- Soft EVA padded material with tough plastic plates
- Knee and elbow pads are kept in place with two elastic velcro straps.
- Suitable for skateboard, biking, mini bike riding and other extreme sports.
- In-box contents : 1 head guard, 2 elbow guards, 2 palm guards, 2 knee guards.

KX-SPS



PROTECTIVE HELMET MULTIPURPOSE  
KX-SHJ



PUSH YOUR LIMITS



## TABLE TENNIS TABLE **LEISURE**

Leisure is specially designed for tournaments and competitions, made of high quality 25mm & 18mm thick pre-laminated particle board with faster speed and even bounce. Comes with lockable wheels and adjustable levelers. Easy to install and includes two box (TT Table & Fittings.)

KX-TTL2525

### General Features :

- Table Size : 2740 x 1525 x 760 cm
- Board Thickness/Type : 25mm, Pre-Laminated Particle Board
- Board Color : Electric Blue
- Base Frame Material : Steel & Powder Coated
- Base Frame Color : White & Grey
- Base Frame Size : 60mm x 20mm
- Leg Size : 100mm x 50mm
- Wheel Size : 125mm
- Foldable : Yes



BOARD THICKNESS  
25 MM



CORNER  
GUARD



125 MM  
WHEELS



LEVELER FOR  
BETTER STABILITY



LOCKABLE  
WHEELS



PULL  
TO OPEN

EASY TO PULL  
HANDLES





## TABLE TENNIS TABLE

## TABLE & ACCESSORIES

### TABLE TENNIS TABLE - COMPETITION

KX-TTC2500



#### General Features :

- Table Size : 2740 x 1525 x 760 cm
- Board Thickness/Type : 25mm, Pre-Laminated Particle Board
- Board Color : Electric Blue
- Base Frame Material : Steel & Powder Coated
- Base Frame Color : Black & Red
- Base Frame Size : 25mm x 50mm
- Leg Size : 50mm x 50mm
- Wheel Size : 100mm Locked
- Foldable : Yes



### TABLE TENNIS TABLE - MAX5000

KX-TTMX5000



#### General Features :

- Table Size : 2740 x 1525 x 760 cm
- Board Thickness/Type : 25mm, Laminated Particle Board
- Board Color : Electric Blue
- Base Frame Material : Steel & Powder Coated
- Base Frame Color : Black & Red
- Base Frame Size : 38mm x 25mm
- Leg Size : 38mm x 38mm
- Wheel Size : 75mm
- Foldable : Yes



**TABLE TENNIS TABLE - LEGEND**
**KX-TTL1875**

**General Features :**

- Table Size : 2740 x 1525 x 760 cm
- Board Thickness/Type : 18mm, Pre-Laminated Particle Board
- Board Color : Electric Blue
- Base Frame Material : Steel & Powder Coated
- Base Frame Color : Black & Red
- Base Frame Size : 38mm x 25mm
- Leg Size : 38mm x 38mm
- Wheel Size : 75mm
- Foldable : Yes

**TABLE TENNIS TABLE - CLUB**
**KX-TTC1875**

**General Features :**

- Table Size : 2740 x 1525 x 760 cm
- Board Thickness/Type : 18mm, Laminated Particle Board
- Board Color : Electric Blue
- Base Frame Material : Steel & Powder Coated
- Base Frame Color : Black & Red
- Base Frame Size : 31mm x 20mm
- Leg Size : 25mm x 25mm
- Wheel Size : 50mm
- Foldable : Yes



## TABLE TENNIS TABLE

## TABLE & ACCESSORIES

### TABLE TENNIS TABLE - MAGNA

KX-TTM1800



#### General Features :

Table Size :  
2740mm x 1525mm x 760cm

Base Frame Size :  
31mm x 20mm

Leg Size :  
25mm x 25mm

### TABLE TENNIS TABLE - MINI

KX-TTMI1800



#### General Features :

Table Size :  
72 x 36 x 27 cm

Base Frame Size :  
31mm x 20mm

Leg Size :  
25mm x 25mm

Wheel Size :  
50 mm

**TABLE TENNIS TABLE NET CLAMP PREMIUM**

- Net Clamp Premium is made of high quality metal (coated with black powder) with complete balance. Perfect for heavier TT Table models.

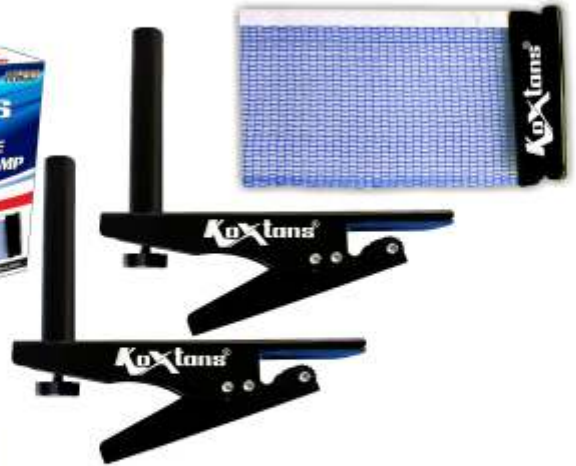
**KX-TTNCP**

**TABLE TENNIS TABLE NET CLAMP ECONOMY**

- Net Clamp Economy is made of high quality metal (coated with black powder) with complete balance. Perfect for heavier TT Table models.

**KX-TTNC E**

**TABLE TENNIS NET**

- TT Table Net comes in blue & black colour.

**KX-TTNET**

**TABLE TENNIS SCORE BOARD**

- TT Table Score Board comes with 0 to 100 numbers.

**KX-TTSB**

**TABLE TENNIS TABLE ARENA**

- TT Table Court Arena for TT Court fencing which can also be used for all indoor games.

**KX-TTCA100**

**TABLE TENNIS COVER**
**KX-TTC**



**TT BAT IMPACT (★★★★★)**

- Impact Five Star TT Racket features comfortable handle & a better grip.

KX-TTBI



**TT BAT FORCE (★★★★)**

- Force Four Star TT Racket features comfortable handle & a better grip.

KX-TTBF



**TT BAT THREE STAR (★★★)**

- Three Star TT Racket features comfortable handle & a better grip.

KX-TTB3S



**TT BAT TWO STAR (★★)**

- Two Star TT Racket features comfortable handle & a better grip.

KX-TTB2S



**TT BAT ONE STAR (★)**

- One Star TT Racket features comfortable handle & a better grip.

KX-TTB1S



**TT BAT EASY SHOT**

- Easy Shot TT Racket is for beginners, features comfortable handle & a better grip.

KX-TTBES



TT BALLS - TOURNAMENT  
KX-TTBLT



TT BALLS - 3 STAR  
KX-TTBL3S



TT BALLS - 2 STAR  
KX-TTBL2S



TT BALLS - 1 STAR  
KX-TTBL1S



TT BALLS - (FORCE)  
KX-TTBLF



TT BALLS - (KLUB)  
KX-TTBLK

**POOL TABLE CLUB**

Pool Table Size : 8'x4'  
 Solid Wood, 4 Legs  
 Indian Slates 1½" in 3 Pcs & English Cloth,  
 Polished Suitable for club or private use.  
 Standard accessories included  
**KX-PTC**



**POOL TABLE TOURNAMENT**

Pool Table Size : 8'x4'  
 Solid Wood, 6 Legs  
 Italian Slates 1½" in 3 Pcs & English Cloth,  
 Polished Suitable for club or private use.  
 Standard accessories included  
**KX-PTTM**



**DISCUS - ELEGANT**

- Made as per standard rules and regulation, SS rim weight 85% of discus with ABS side plastic plates for better performance and long life.

<b>KX-DEA200</b>	2.00 Kg
<b>KX-DEA150</b>	1.50 Kg
<b>KX-DEA100</b>	1.00 Kg



**DISCUS - HI SPIN**

- Made as per standard rules and regulation, Steel rim weight 80% of discus with ABS plastic plates for better performance and long life.

<b>KX-DHA200</b>	2.00 Kg
<b>KX-DHA150</b>	1.50 Kg
<b>KX-DHA100</b>	1.00 Kg

**DISCUS - LO SPIN**

- Made as per standard rules and regulation, Steel rim weight 70% of discus with ABS plastic plates for better performance and long life.

<b>KX-DLA200</b>	2.00 Kg
<b>KX-DLA150</b>	1.50 Kg
<b>KX-DLA100</b>	1.00 Kg



**DISCUS - CLUB (WOODEN)**

- Made as per standard seasoned wood for better performance and long life.

<b>KX-DCW200</b>	2.00 Kg
<b>KX-DCW150</b>	1.50 Kg
<b>KX-DCW100</b>	1.00 Kg

**DISCUS - RUBBER BLACK**

- Rubber Discus made of high quality strong rubber and single piece construction for extra durability, will not sustain any mark or harm the floor while in use.

<b>KX-DRB200</b>	2.00 Kg
<b>KX-DRB150</b>	1.50 Kg
<b>KX-DRB100</b>	1.00 Kg





## HAMMER

## ATHLETICS TRACK & FIELD

### HAMMER BRASS

- Hammer made of brass as per IAAF standard specification with ball bearing swivel.
- Comes with handle & wire.

<b>KX-HB726110</b>	7.26 Kg	110 mm
<b>KX-HB600107</b>	6.00 Kg	107 mm
<b>KX-HB545103</b>	5.45 Kg	103 mm
<b>KX-HB500100</b>	5.00 Kg	100 mm
<b>KX-HB400095</b>	4.00 Kg	95 mm



### HAMMER STEEL ALLOY

- Alloy Hammer made of high quality steel as per IAAF regulations with ball bearing swivel. Comes with handle & wire.

<b>KX-HA726115</b>	7.26 Kg	115 mm
<b>KX-HA600105</b>	6.00 Kg	107 mm
<b>KX-HA545103</b>	5.45 Kg	103 mm
<b>KX-HA500100</b>	5.00 Kg	100 mm
<b>KX-HA400095</b>	4.00 Kg	95 mm

### HAMMER CAST IRON TURNED

- Cast Iron Hammer exactly machine turned for accurate weight and diameter.
- Comes with handle & wire.

<b>KX-HCIT726</b>	7.26 Kg	110 mm
<b>KX-HCIT600</b>	6.00 Kg	107 mm
<b>KX-HCIT545</b>	5.45 Kg	103 mm
<b>KX-HCIT500</b>	5.00 Kg	100 mm
<b>KX-HCIT400</b>	4.00 Kg	95 mm
<b>KX-HCIT363</b>	3.63 Kg	95 mm



### HAMMER CAST IRON UNTURNED

- Cast Iron Turned Hammer with accurate weight.
- Comes with handle & wire.

<b>KX-HCIU726</b>	7.26 Kg
<b>KX-HCIU600</b>	6.00 Kg
<b>KX-HCIU545</b>	5.45 Kg
<b>KX-HCIU500</b>	5.00 Kg
<b>KX-HCIU400</b>	4.00 Kg
<b>KX-HCIU363</b>	3.63 Kg

**HAMMER WIRE**

- Hammer wire made 3mm durable steel construction for strength and flexibility.
  - Great for practice and competition.
  - Great for any training session.
  - Customized lengths are also available on request.
- KX-HWS30**

**HAMMER HANDLE**

- Hammer Handle made of steel & aluminium.
  - Straight Aluminium Hammer handle
- KX-HHSS**

**HAMMER HANDLE**

- Hammer Handle made of steel & aluminium.
  - Straight Steel Hammer handle
- KX-HHAC**

**HAMMER GLOVES**

- Hammer gloves made of high quality leather feel material.
- KX-HGLL**
- Left hand - large



## SHOT PUT

## ATHLETICS TRACK & FIELD

### SHOT PUT BRASS - TURNED

- Brass turned shot put made as per standard specification.
- Shell made of brass, filled with special mixture of lead.
- Machine turned for accurate diameter.

KX-SB726129	7.26 Kg	129 mm
KX-SB600107	6.00 Kg	107 mm
KX-SB500100	5.00 Kg	100 mm
KX-SB400095	4.00 Kg	95 mm
KX-SB300087	3.00 Kg	87 mm



### SHOT PUT - ALLOY

- Made as per IAAF standard specification.
- Shot Put shell made of stainless steel Alloy, filled with special mixture of lead.
- Machine turned for accurate diameter.

KX-SA726129	7.26 Kg	129 mm	
KX-SA600115	6.00 Kg	115 mm	
KX-SA500100	5.00 Kg	100 mm	
KX-SA400095	4.00 Kg	95 mm	
KX-SA300087	3.00 Kg	87 mm	

### SHOT PUT CAST IRON - TURNED

- Cast iron shot put machine turned for accurate weight filled with special mixture of lead.

KX-SCIT726	7.26 Kg
KX-SCIT600	6.00 Kg
KX-SCIT545	5.45 Kg
KX-SCIT500	5.00 Kg
KX-SCIT400	4.00 Kg
KX-SCIT363	3.63 Kg
KX-SCIT300	3.00 Kg
KX-SCIT200	2.00 Kg



### SHOT PUT CAST IRON- UNTURNED

- Made as per IAAF specification and perfect for Track and Field events. Made of Iron.
- Precisely machine turned for accurate diameter, weight and perfect balance.
- Available in different Weights and Diameters.

KX-SCIU726	7.26 Kg
KX-SCIU600	6.00 Kg
KX-SCIU545	5.45 Kg
KX-SCIU500	5.00 Kg
KX-SCIU400	4.00 Kg
KX-SCIU363	3.63 Kg



### SHOT PUT RUBBER

KX-SPR100 1 Kg



**STARTING BLOCK - INTERNATIONAL**

- Made as per IAAF specification in 75mm aluminium channel and SS plates having rust proof spikes with good quality heavy aluminium paddles and rubber pads.
- One of the best starting blocks for competition to give better start to an athlete.

**KX-SBAI**

**STARTING BLOCK - TRAINING**

- Made as per standard specification for track and field equipment in steel double pipe rail channel with good quality paddle having synthetic padding for better grip.
- All steel construction with synthetic rubber pads.

**KX-SBST**

**STARTING BLOCK - SCHOOL**

- Made of single steel pipe and paddle with synthetic rubber padding.
- Good for practice in school.

**KX-SBSS**



**CROSSBAR - COLOURED**

- High Jump & Pole Vault Crossbars are made of aluminium, fiber & steel, applied colour for better visibility of the athletes.
- Our high jump cross bars are light weight and yet sturdy, durable and reliable.
- These Cross Bars meets the IAAF specification.
- Also available in fibre and steel.

<b>KX-CBHJF40</b>	4 mtr Fiber crossbar with end caps
<b>KX-CBPVF45</b>	4.5 mtr Fiber crossbar with end caps
<b>KX-CBHJA40</b>	4 mtr Aluminium crossbar with end caps
<b>KX-CBPVA45</b>	4.5 mtr Fiber crossbar with end caps
<b>KX-CBHJS40</b>	4 mtr Steel crossbar with end caps
<b>KX-CBPVS45</b>	4.5 mtr Steel crossbar with end caps

**JAVELIN ALUMINIUM - TRAINING**

- Made of aluminium tail and steel head.
- An ideal Javelin for school and college level training & competition.

- KX-JAT500**
- KX-JAT600**
- KX-JAT700**
- KX-JAT800**

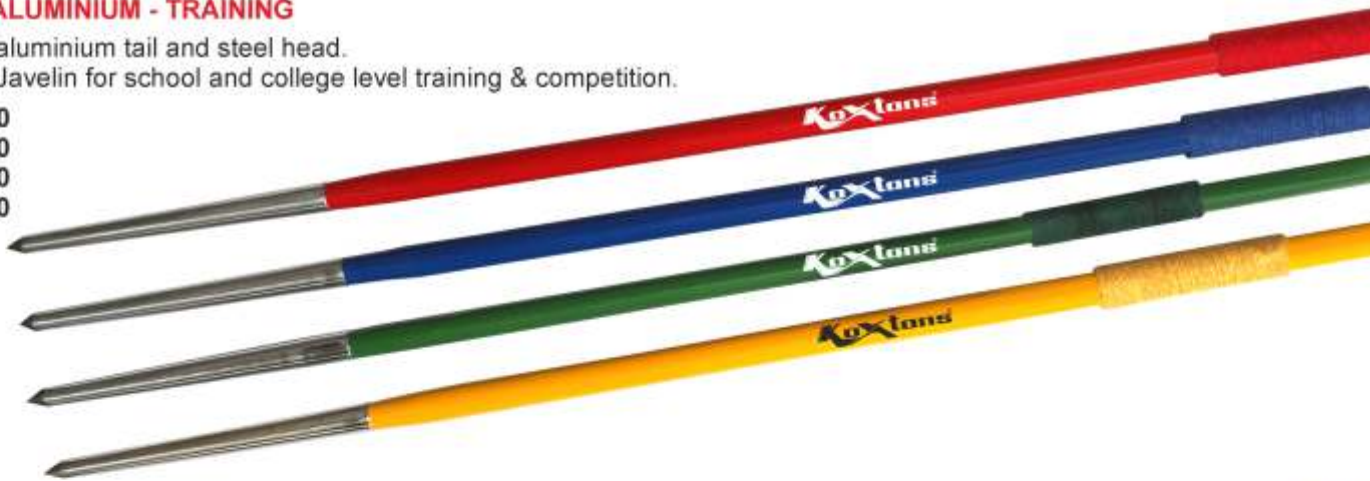

**JAVELIN BAMBOO**

- Made of bamboo traditionally an ideal Javelin for training purpose.

- KX-BJMWPC** POWDER COATED
- KX-BJMWC** CHROME



**STEEL HURDLE TOURNAMENT**

- Made as per IAAF standard specification for competition with height adjustment system.
- Made of steel square pipe and portable.

**KX-HSPT**

- Meets IAAF requirement.

**STEEL HURDLE COMPETITION**

- Made as per IAAF standard specification for competition with height adjustment system.
- Made of steel square pipe.
- Counter weights that meets official pull-over forces.

**KX-HSFC**

- Meets IAAF requirement.

**STEEL HURDLE - REGULAR**

- Made as per IAAF standard specification for the track and field events for practice and competition having height adjustment system
- Made of Steel.

**KX-HSR**

- Meets IAAF requirement.

**HURDLE****STEEL HURDLE - TRAINING**

- Made as per for the track and field events for practice and competition having height adjustment system.

**KX-HST**

- Meets IAAF requirement.

**HURDLE - SCISSOR**

- Scissor hurdle made of steel tube.
- Lightweight durable fiber top bar with recessed legs and height adjustable from 9" to 36".

**KX-HSS****HURDLE - PLANK**

- Made from a highly resistant plastic profiles.

**KX-HP**

**POLE VAULT STAND**

- Light weight standard, with uprights and heavy steel base for stability.
- Meets IAAF specifications.
- Uprights with telescoping riser.
- Heavy Steel Base.
- Detachable for easy transportation and storage.
- Also includes 8 Anchor pins. Height adjustment from 12'-19'.

**KX-PVUS** School

**POLE VAULT STAND**

- Light weight standard, with uprights and heavy steel base for stability.
- Meets IAAF specifications.
- Uprights with telescoping riser.
- Heavy Steel Base.
- Detachable for easy transportation and storage.
- Also includes 8 Anchor pins. Height adjustment from 12'-19'.

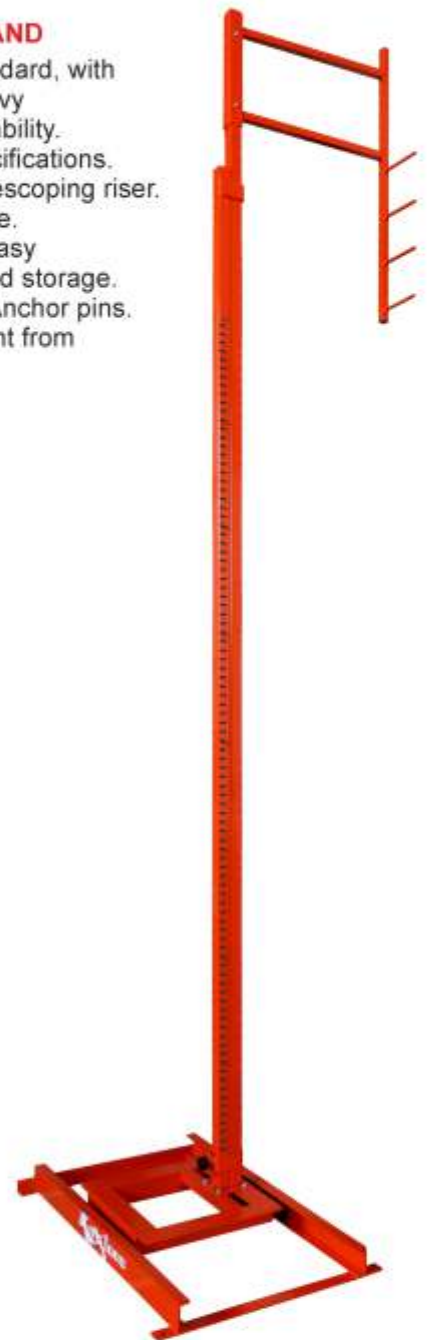
**KX-PVUC** Club

**POLE VAULT TROUGH STEEL**

- Made as per IAAF standard specification for track and field pole vault jump event.

**KX-PVTR** Regular (Steel)



**HIGH JUMP STAND- PREMIUM**

High Jump Stand Premium can be used for both training and competitions. Meets IAAF specifications.

- High Jump stand is made from powder coated steel uprights.
- Heavy duty steel with rollaway base
- Easy Height Adjustments
- Steel constructed risers with welded bar rests
- Height adjustment from 1.60 m to 2.50 m

**KX-HJSP****HIGH JUMP STAND - REGULAR**

High Jump Stand Regular can be used for both training and competitions. Meets IAAF specifications.

- High Jump stand is made from powder coated steel uprights.
- Heavy duty steel with rollaway base
- Easy Height Adjustments
- Steel constructed risers with welded bar rests
- Height adjustment from 1.60 m to 2.50 m

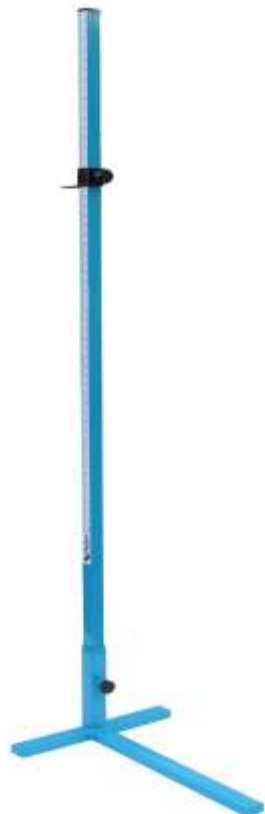
**KX-HJSR****HIGH JUMP STAND - ECONOMY**

- High Jump Stand Economy made of steel tubular pipe and base made of heavy duty rectangular tube filled with weight for stability.
- PVC scale & powder coated.
- Maximum height adjustment up to 2.10 m.

**KX-HJSE**

**OLYMPIC HIGH JUMP PIT**
**KX-HJPO**      6.0 m x 4.0 m x 70 cm      Olympic Model

**HIGH JUMP PIT**

- Made as per IAAF standard specification for training and competition level.
- High density PU Foam with Non-Tearing Vinyl cover.
- Available in different Weights and Diameters.

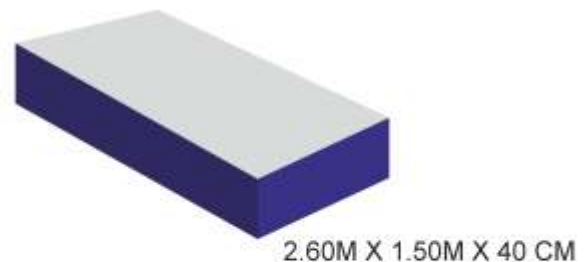
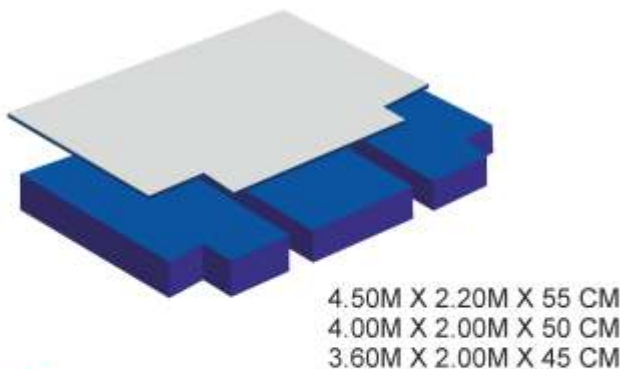
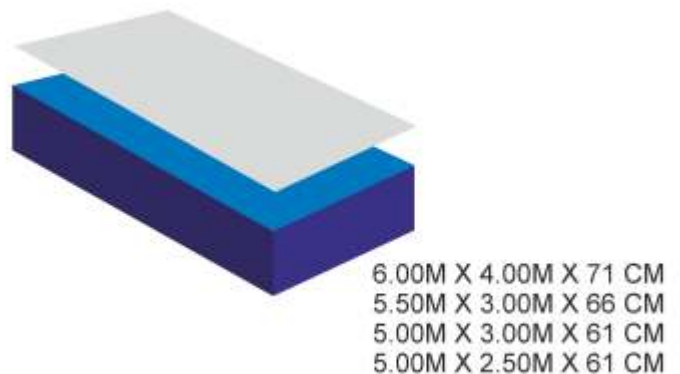
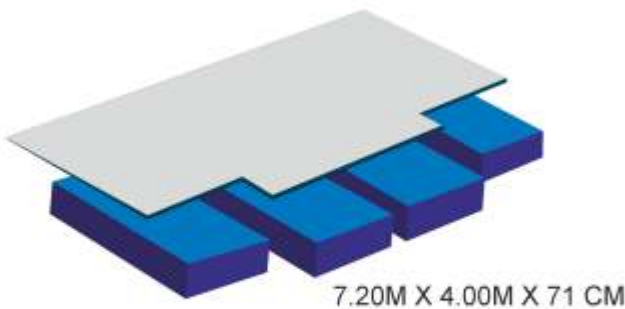

## POLE VAULT PIT | TOE BOARD

## ATHLETICS TRACK & FIELD

### POLE VAULT PIT

- Made as per IAAF standard specification for training and competition level.
- High density PU Foam with Non-Tearing Vinyl cover.

<b>KX-PVPS</b>	6.3 m x 5.0 m x 60 cm School Model
<b>KX-PVPP</b>	7.0 m x 5.0 m x 80 cm Practice Model
<b>KX-PVPO</b>	8.0 m x 6.0 m x 80 cm Olympic Model



### TOE BOARD

- Made as per IAAF standard specification for the track and field throwing events.

<b>KX-TBS</b>	STEEL
<b>KX-TBW</b>	WOODEN



### TAKE OF BOARD- WOODEN

- Made as per IAAF standard specification and best for the track and field event like long jump and triple jump.
- KX-TOBW**

**PLYOMETRIC TRAINING BOX - STEEL**

- Made of 25mm square tube, fully welded frame and top having antiskid rubber for better performance.
- One set includes 5 pcs. Each of 12", 18", 24", 30" & 36".
- Powder coated for extra durability.
- Covered with fabric.

**KX-PMTBS5**

**DISCUS | HAMMER | SHOT PUT THROWING CIRCLE**

- Made as per IAAF rules and regulations in two pieces easy to install.

**KX-DCS**      Discus Circle Steel  
**KX-HSCS**     Hammer & Shotput Circle Steel

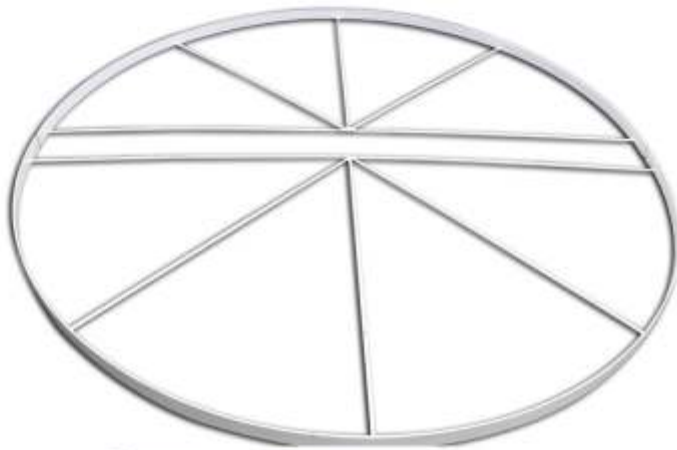
**ROSTRUM STAND/ JUDGES STAND**

- Made of 2" square steel painted/powder coated with wheels for easy transportation.

**KX-RJSS**

**STARTER CLAPPER**

- Made of wood for best performance with dual color plates.

**KX-SCW**

**VICTORY STAND PORTABLE**

- Made of Steel, powder coated for extra durability.
- Fits telescopically in a box to reduce volume while packing.
- Bolted together for stability.

KX-VSF (Fixed)

KX-VSP (Portable)

(Portable)



(Fixed)



**LINE MARKING MACHINE**

- Line marking machine for marking lines in different event (dry) 5 cm thick to spread uniformly

KX-SLMMR Single line



**LINE MARKING MACHINE**

- Line marking machine for marking lines in different event (dry) with 5 cm thick to spread uniformly.

KX-DLMMR Double line



**JAVELIN CARRYING CART**

- Made of heavy steel tube. Suitable for 18 javelins.
- Comes with extra durable wheels.
- Foldable to reduce freight cost.

**KX-JCR18****JAVELIN CARRYING RACK**

- Made of heavy steel tube.
- Suitable for 18 javelins.
- Foldable to reduce freight cost.

**KX-JRR18****JAVELIN CARRYING CART CLUB**

- Made of heavy steel tube.
- Suitable for 18 javelins.
- Comes with wheels.

**KX-JCC18****HURDLE CART**

- Cart is made of steel, with larger diameter wheels for easy transportation.
- Powder coated for durability and comes in 2 variants to carry 10 and 20 hurdles.

**KX-HCR**

## CARRYING CART

## ATHLETICS TRACK & FIELD

### STARTING BLOCK CART

- Cart is made of steel and can easily carry 8 starting blocks.
- Features powder coating, heavy duty wheels with locking device.

**KX-SBCR**



### SHOT PUT CARRYING CART

- Made of heavy duty steel tube. Suitable for 15 to 20 shots.
- Comes with extra durable wheels.
- Foldable to reduce freight cost.

**KX-SPCR**

### DISCUS AND SHOT CARRYING CART

- Made of heavy duty steel tube. Suitable for 24 discus and 14 shots.
- Comes with extra durable wheels.
- Foldable to reduce freight cost.

**KX-DSCCR**



### DISCUS CARRYING RACK

- Made of heavy duty steel tube.
- Suitable for 28 discus.
- Foldable to reduce freight cost.

**KX-DSRE26**

**VAULTING TABLE**

- Vaulting Table - Heavy duty steel base pipe 125mm x 75mm with 75mm support pipe.
- Top thickness 80mm covered by non slip fabric with foam for better rebound along with height adjustment 105cm to 135cm.
- Made as per standard rules & regulation.

**KX-GVT2013P**

- Vaulting Table - Premium with Heavy Base

**KX-GVT2013E**

- Vaulting Table - Economy with Regular Base

**PARALLEL BAR**

- Made as per standard rules & regulation size 3.5 mtr with heavy steel structure base pipe 125 mm x 75 mm & 75 mm round support pipe along with fiber glass bars.

**KX-GPB2006**



**BALANCING BEAM**

- Balancing Beam - Heavy duty steel structure of 75 mm round used in base & support pipe along with height adjustment from 110 cm to 150 cm as per regulation.
- Quality wooden surface with Non slip fabric for better performance.

**KX-GBB2001****POMMEL HORSE**

- Pommel Horse - Heavy Steel Base Pipe 125 x 50mm & 75 mm Round Support Pipe, Height Adjustable from 110 cm to 150 cm.

**KX-GBPH2007****VAULTING HORSE**

- Vaulting Horse made as per standard rules regulation, with heavy steel base pipe 125 mm x 50 mm & 75 mm round support pipe with quality wooden top & foam padding.
- Height adjustable from 110 cm to 150 cm.

**KX-GVH2012**

**TRAMPOLINE FULL SIZE**

- Trampoline - Standard made of 5.2 X 3.15 mtr Heavy duty tubular steel frame 100 mm x 50 mm x 3 mm base 50 mm x 70 mm with springs & foam padding.

**KX-TRF**

**TRAMPOLINE STANDARD**

- Trampoline - Standard made of 3x3mtr Heavy duty tubular steel frame 100 mm x 50 mm x 3 mm base 50 mm x 50 mm with springs & foam padding.

**KX-TRS**

**TRAMPOLINE - MINI**

- Made of 1.2 X 1.2 mtr Heavy duty steel frame with springs & foam padding.
- Size :1.20 mtr x 1.20 mtr.

**KX-TRM**

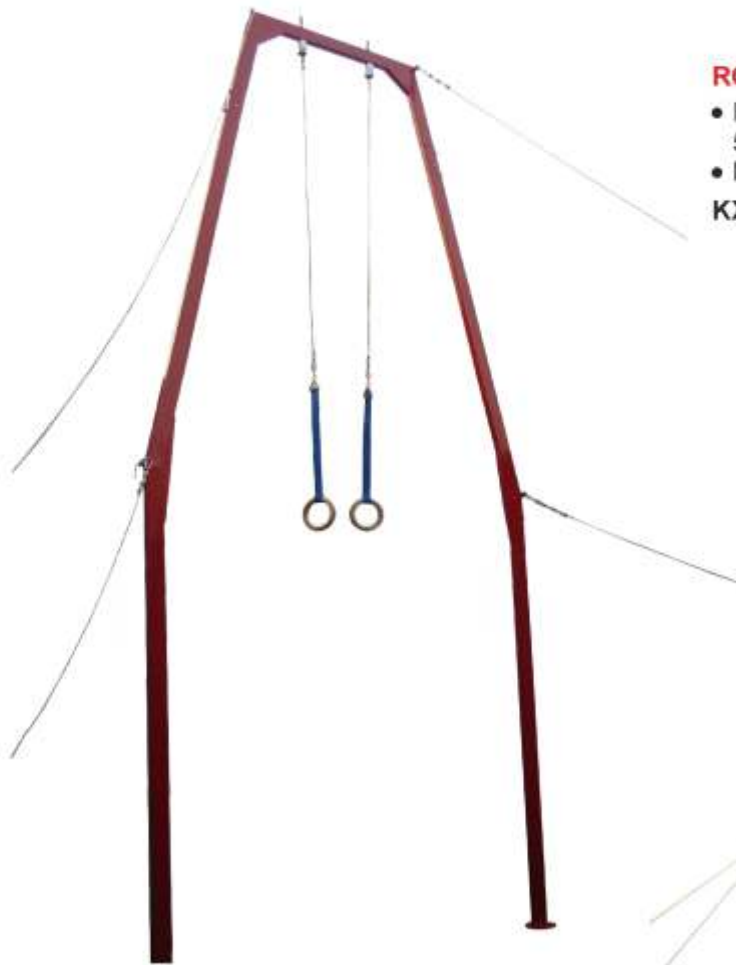
**ROMAN RING APPARATUS**

- Heavy Steel Tubular Structure 100mm x 50mm height 575 cm along with spring on top and wooden rings.
- Made as per standard rules & regulation.

**KX-GRR2008**



**HORIZONTAL BAR**

- Horizontal Bar made of 75 mm round heavy duty steel tubular structure with steel bar.
- As per standard rules & regulation.
- Also available with height adjustment from 255 cm to 295 cm

**KX-GHB2004**



**UNEVEN BAR**

- Made of heavy duty steel base pipe 100mmx50mm & 75mm, support pipe bars made of fiber glass for flexibility and best performance.

**KX-GHB2011**

**MUSHROOM HORSE**

- Heavy Duty Steel Base Plate 600mm x 10mm, Support Pipe 200mm.
- Pounds with quality wooden top & foam Padding.

**KX-GMH2006****VAULTING BOX WOODEN****KX-GVB2014****SPRING BOARD/ VAULTING BOARD****KX-GSB2009****GYMNASTIC BENCH****KX-GMB2004****GYMNASTIC WALL BAR****KX-GWB2015**

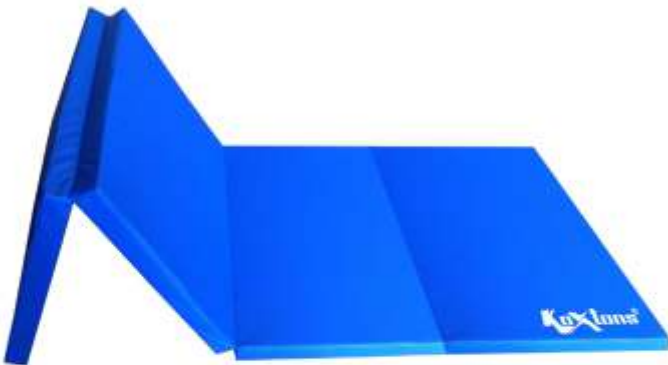

**GYMNASTIC MAT FOLDING - REGULAR**

- Regular folding mat made of EP foam in four folds with quality fabric and comes in 50 mm thickness.
- Available size is 2.4 mtr x 1.2 mtr

**KX-GMFR**



**GYMNASTIC MAT FOLDING MULTI COLOUR**

- Regular folding mat multi colour made of EP foam in four folds with quality fabric and comes in 50 mm thickness.
- Available size is 2.4 mtr x 1.2 mtr

**KX-GMFM**



**GYMNASTIC CRASH MAT - PREMIUM**

- Gymnastic Crash Mat - Premium comes in high density PU foam with quality fabric & 30 cm thickness and comes along with non-tearing fabric.
- Available Size : 3 mtr x 2 mtr x 30 cm

**KX-GCMP3230**



**GYMNASTIC MAT PU - PREMIUM**

- Gymnastic Mat - Premium is made of good quality PU foam.
- Gymnastic Mat - Premium comes with non-tearing fabric.
- It comes in different thickness 10 cm, 20 cm & 30 cm.

**KX-GMPP2110** 10 cm Thickness  
**KX-GMPP2120** 20 cm Thickness



**GYMNASTIC OCTAGON**

- Available in two colours - Red/Blue

**KX-GON**

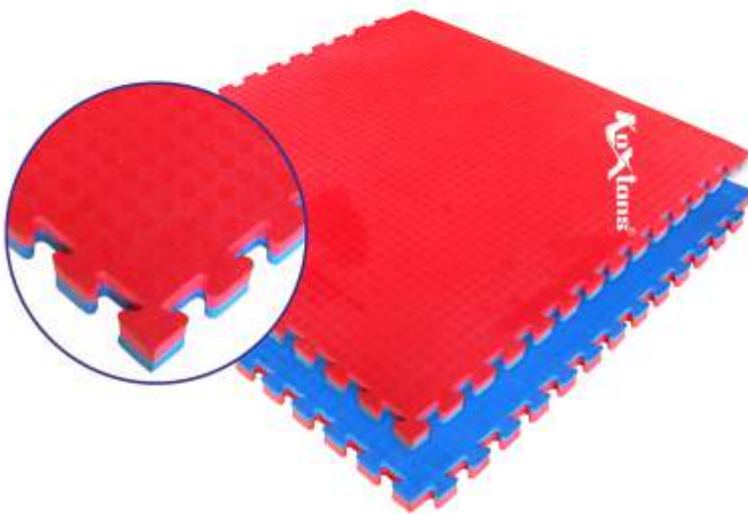
**KABADDI MAT - PREMIUM**

- Made of high density EVA foam with soft core in the middle that provides maximum cushioning to reduce strain.
- Available size is 1m x 1m interlocking, regular quality with different thickness 20mm, 25 mm & 30 mm

<b>KX-KMP20</b>	20 mm Thickness
<b>KX-KMP25</b>	25 mm Thickness
<b>KX-KMP30</b>	30 mm Thickness

**KABADDI MAT - REGULAR**

- Made of high density EVA foam with soft core in the middle that provides maximum cushioning to reduce strain.
- Available size is 1m x 1m interlocking, premium quality with different thickness 20mm, 25 mm & 30 mm

<b>KX-KMR20</b>	20 mm Thickness
<b>KX-KMR25</b>	25 mm Thickness
<b>KX-KMR30</b>	30 mm Thickness

**GYMNASTIC MAT EP - PREMIUM**

- Gymnastic EP Mat - Premium is made of good quality EP foam with 50 mm thickness, it comes with heavy duty vinyl fabric.
- Available size is 2 mtr x 1 mtr x 50 mm

<b>KX-GMEP2105</b>	50 mm Thickness
<b>KX-GMEP2110</b>	100 mm Thickness

**GYMNASTIC MAT EP - REGULAR**

- Gymnastic EP Mat - Regular is made of good quality EPP foam with 50 mm thickness.
- It comes with vinyl cover.
- Available Size : 2 mtr x 1 mtr x 50 mm

<b>KX-GMER2105</b>	50 mm Thickness
<b>KX-GMER2110</b>	100 mm Thickness



**JUDO MAT - REGULAR & PREMIUM**

- Made of EP & JSR foam with good quality vinyl/canvas.
- Comes with antiskid material base.

**KX-JMR**

- Regular 2 mtr x 1 mtr x 50 mm (EP + JSR)

**KX-JMP**

- Premium 2 mtr x 1 mtr x 50 mm (JSR only)



**RUNWAY MAT PREMIUM**

**KX-RMP**

1mtr x 25mtr x 12mm



**RUNWAY MAT**

**KX-RM124** 1mtr x 24ft

**KX-RM130** 1mtr x 30ft

APPROVED BY  
**WRESTLING FEDERATION OF INDIA**  
 SET CONSIST OF 72 MATS & COVERS

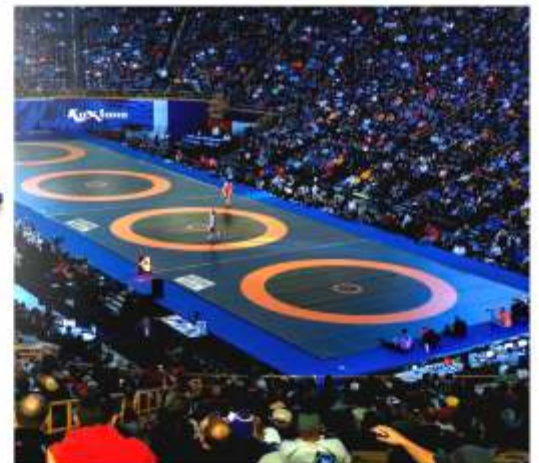

**WRESTLING MAT COVER**

KX-WMCN NATIONAL  
 KX-WMCI INTERNATIONAL

\*Also available on order



**WRESTLING MAT**

- Made of high density EVA foam.
- Comes in different thickness.
- Also available in sets with FILA standard top corner.

<b>KX-WMR2105</b>	2 mtr x 1 mtr x 50 mm
<b>KX-WMR2106</b>	2 mtr x 1 mtr x 60 mm
<b>KX-WMR2107</b>	2 mtr x 1 mtr x 70 mm





## 3-IN-1 MULTI PURPOSE WEIGHT BENCH

It can be used for incline or decline and flat bench press, push ups, dumbbell fly, dumbbell press

KX-MPWH3-1



3 IN 1 POSITION  
INCLINE / DECLINE / FLAT



INCLINE



DECLINE

**IMPORTED SERIES****KOXTONS SHOULDER PRESS**  
KX-1626**KOXTONS LEG EXTENSION**  
KX-1627**KOXTONS PRONE LEG CURL**  
KX-1637**KOXTONS REAR DELT/PEC FLY**  
KX-1638**KOXTONS INCLINE CHEST PRESS**  
KX-11655**KOXTONS VERTICAL CHEST PRESS**  
KX-1620**KOXTONS LAT PULLDOWN**  
KX-1604**KOXTONS PULLEY LOW ROW**  
KX-1606**KOXTONS BICEP CURL**  
KX-1625

\*Please confirm the availability of stock before placing your purchase order.



**KOXTONS SEATED LEG CURL**  
KX-1624



**KOXTONS KNEELING TYPE DIP  
CHIN ASSIST**  
KX-1623



**KOXTONS SMITH MACHINE**  
KX-1617



**KOXTONS LAT PULLDOWN  
& LOW ROW (COMBO)**  
KX-1659



**KOXTONS LEG EXTENSION  
LEG CRUL (COMBO)**  
KX-1658



**KOXTONS SHOULDER PRESS +  
CHEST PRESS (COMBO)**  
KX-1663



**KOXTONS 45 DEGREE LEG PRESS**  
KX-1656



**KOXTONS LEG PRESS HACK SLIDE (COMBO)**  
KX-1662

\*Please confirm the availability of stock before placing your purchase order.

**DELUX SERIES****OLYMPIC BENCH INCLINE**  
KX-DXOBI**OLYMPIC BENCH FLAT**  
KX-DXOBF**OLYMPIC BENCH DECLINE**  
KX-DXOBD**LAT PULLEY**  
KX-DXLP**SHOULDER PRESS**  
KX-DXSP**LEG CURL**  
KX-DXLC**PECK FLY REAR DELT**  
KX-DXPF**CHEST PRESS**  
KX-DXCP**SEATED LEG CALF RAISE**  
KX-DXSLCR

**DELUX SERIES****WRIST CURL**  
KX-DXWC**45 DEGREE LEG PRESS**  
KX-DXLP45**HYPER EXTENSION BENCH**  
KX-DXHB**CABLE CROSS OVER**  
KX-DXCC

**REGULAR SERIES WITH HALF COVER 4X2****SHOULDER PRESS  
KX-RSP****BENCH PRESS  
KX-RBP****PECK FLY  
KX-RPF****TRICEP PUSH DOWN  
KX-RTPD****PREACHER CURL  
KX-RPC**

REGULAR SERIES 4"X2"



BENCH PRESS WORK  
OUT-REGULAR  
KX-BWO



ABDOMINAL BOARD- REGULAR  
KX-ABL



PREACHER CURL  
REGULAR  
KX-BPC



MULTI PURPOSE BENCH PRESS  
(FLAT/INCLINE/DECLINE)  
REGULAR  
KX-PBSID



TWIN TWISTER (MULTI)  
REGULAR  
KX-TM



FOLDING TWISTER  
KX-FWR

**REGULAR SERIES 4"X2"****T-BAR  
KX-ICTB602****PULL UPS WITH PARALLEL BAR  
KX-ICPU604****VERTICAL DIP STAND  
KX-ICVDS605****ADJUSTABLE WEIGHT BENCH  
KX-BAW****ECONOMY SERIES 2"X2"****BENCH WORK OUT ECONOMY  
KX-BO****BODY TWISTER ECONOMY  
KX-TSE**



**INDIAN POWER SERIES****INCLINE CHEST PRESS  
KX-IPICP****CHEST PRESS  
KX-IPCP****LEG PRESS  
KX-IPLP****LOW ROW  
KX-IPLR****SUPER SQUAT  
KX-IPSS****ABS CRUNCH MACHINES  
KX-ABSCM**

**MANUAL TREADMILL 4 IN 1**

- Includes bearings for smooth leg movement.
- Made of Heavy Quality Frame along with **Movable wheel**, stepper, twister and Dips Stand.

**KX-MT41**

**AIRBIKE KX-250**

- Movable handle for easy movement of shoulder along with body twister with height adjustable seat.
- NW 22.4 Kg
- GW 25.4 Kg

**KX-AIR250**

**AIRBIKE KX-200**

- Movable handle for easy movement with height adjustable seat.
- NW 17.9 Kg
- GW 20.7 Kg

**KX-AIR200**

**AIRBIKE KX-100**

- Airbike fix handle for home use.
- Different adjustment levels of seat.
- NW 16.8 Kg
- GW 19.6 Kg

**KX-AIR100**



**MULTI STATION GYM MACHINE  
6 STATION (320 Kg)  
4"X2"  
KX-MSG6 MS Plate**

**MULTI STATION GYM MACHINE  
12 STATION (650 Kg)**

4"X2"  
KX-MSG12 MS Plate  
KX-MSG12 PVC Plate

2"X2"  
KX-MSGE12 MS Plate  
KX-MSGE12 PVC Plate



**MULTI STATION GYM MACHINE  
10 STATION (500 KG)****4"X2"****KX-MSG10 MS Plate****KX-MSG10 PVC Plate****2"X2"****KX-MSGE10 MS Plate****KX-MSGE10 PVC Plate****MULTI STATION GYM MACHINE  
8 STATION (450 Kg)****4"X2"****KX-MSG8 MS Plate****KX-MSG8 PVC Plate****2"X2"****KX-MSGE8 MS Plate****KX-MSGE8 PVC Plate**



**MULTI STATION GYM MACHINE 6 STATION  
(300 Kg)**

- 4"X2"
- KX-MSG6 MS Plate
- KX-MSG6 PVC Plate
- 2"X2"
- KX-MSGE6 MS Plate
- KX-MSGE6 PVC Plate

**MULTI STATION GYM MACHINE 4 STATION  
(225 Kg)**

- 4"X2"
- KX-MSG4 MS Plate
- KX-MSG4 PVC Plate
- 2"X2"
- KX-MSGE4 MS Plate
- KX-MSGE4 PVC Plate



**MULTI STATION GYM MACHINE 4 STATION  
(225 Kg)**

- 4"X2"
- KX-MSG4 MS Plate
- KX-MSG4 PVC Plate
- 2"X2"
- KX-MSGE4 MS Plate
- KX-MSGE4 PVC Plate



## **MULTI FUNCTIONAL TRAINER & SMITH MACHINE (COMBO)**

- Heavy duty frame built in 4 x 2 square pipe
- Diameter of pull up bar: 25mm.
- Dual MS 80 kg stack both sides.
- Weight load capacity 500kg.
- Color - electrostatic powder coat finish.
- Exercises- pin weight multi functional trx training, cable crossover, triceps, biceps, chest press, shoulder press, squats, deadlifts and many more.
- Available in assorted color
- Multi point adjustable mechanism for the sliding section for variable heights.
- Rubber shoes for grip tight alignment

**KX-MFTSM**



## OLYMPIC SET

## WEIGHT LIFTING & FITNESS

### OLYMPIC BARBELL SET - COLOURED

- Weight lifting barbell set made in different weight category with high grade steel Rod and coloured rubberized plates along with cast iron collars. Available in 190 Kg & 140 Kg.

KX-BSC190

KX-BSC140

TOTAL	500gm	1 Kg	1.5 Kg	2 Kg	2.5 Kg	5 Kg	10 Kg	15 Kg	20 Kg	25 Kg	Rod
190Kg	2 Pcs	2 Pcs	2 Pcs	2 Pcs	2 Pcs	2 Pcs	2 Pcs	2 Pcs	2 Pcs	2 Pcs	25
140Kg	x	x	x	x	2 Pcs	2 Pcs	2 Pcs	2 Pcs	x	2 Pcs	25



### OLYMPIC BARBELL SET - BLACK

- Weight lifting barbell set made in different weight category with high grade steel Rod and black rubberized plates along with cast iron collars. Available in 190 Kg & 140 Kg.

KX-BSB190

KX-BSB140

TOTAL	500gm	1 Kg	1.5 Kg	2 Kg	2.5 Kg	5 Kg	10 Kg	15 Kg	20 Kg	25 Kg	Rod
190Kg	2 Pcs	2 Pcs	2 Pcs	2 Pcs	2 Pcs	2 Pcs	2 Pcs	2 Pcs	2 Pcs	2 Pcs	25
140Kg	x	x	x	x	2 Pcs	2 Pcs	2 Pcs	2 Pcs	x	2 Pcs	25





**PENDULUM APPARATUS  
KX-ODGPA**



**AIR WALKER  
KX-ODGAW**



**HIP & WAIST TWISTER  
KX-ODGHT**



**SIT TWISTER  
KX-ODGMT**



**DOUBLE SIT PEDAL EQUIPMENT  
KX-ODGDP**



**TWISTER WITH SIT UP BOARD  
KX-ODGTSB**





**SHOULDER EXERCISE WHEEL**  
KX-ODGSW



**SINGLE POSITION BODY RIDER**  
KX-ODGBR



**PARALLEL BARS**  
KX-ODGPB



**AIR STRIDER**  
KX-ODGAS



**CROSS TRAINER**  
KX-ODGCT



**TEETER LADDER  
KX-ODGTL**



**WALL BARS  
KX-ODGWB**



**PULL UPS & DIPS  
KX-ODGPUD**



**SIT UP BOARD (DOUBLE)  
KX-ODGSB**



**CHILDREN'S SEESAW  
KX-ODGCS**



**TRIPLE WAIST TWISTER**  
KX-ODGTST



**TWISTER & STEPPER**  
KX-ODGTS



**EXERCISE CYCLE**  
KX-ODGEC



**TREADMILL**  
KX-ODGT



**DOUBLE SEATED PUSH TRAINER**  
KX-ODGSPT



**BUTTERFLY**  
KX-ODGB



**PUSH PULL CHAIR**  
KX-ODGPPC



**PUSH UP BAR**  
KX-ODGPUPB



**SKY CLIMBER**  
KX-ODGSKC



**CHIN UP BAR**  
KX-ODGCI



**TAI CHI SPINNER 4 WHEEL**  
KX-ODGTCS4W



**INTEGRATED FITNESS**  
KX-ODGIF



**SINGLE STRETCHER**  
KX-ODGSST



**BACK EXTENSUON**  
KX-ODGBEX



**BENCH SIT UP**  
KX-ODGBSUP



**DRUM BIG SIZE**  
KX-DBSE No Warranty



**DRUM SMALL SIZE**  
KX-DSSE No Warranty



**TORCH**  
KX-MS



**DRUM STAND**  
KX-DSD



**PT LAZIEM  
PREMIUM**  
KX-PTLP



**PT DUMBBELL**  
KX-PTD



**CYCLE STAND**  
KX-CYSD



## CONTENTS



CHAMPIONS KEEP PLAYING  
UNTIL THEY GET IT RIGHT.  
"BILLIE JEAN KING"



### **KOXTONS SPORTS EQUIPMENTS (P) LIMITED**

**Add :** 3/11, Mohkampur Industrial Area, Phase-I,  
Delhi Road, Meerut-250002 (Uttar Pradesh), India.

**Tele Fax :** +91 12125 28994

**M :** +91 9997 998 994, +91 8476 000 166,

**M :** +91 8476 000 167, +91 8476 000 168

**Email :** sales@koxton.com, naveen@koxton.com

**Website :** www.koxtons.com, www.koxtons.com